

Fujitsu LifeBook®
N6460 Notebook

User's Guide

Copyright and Trademark Information

Fujitsu Computer Systems Corporation has made every effort to ensure the accuracy and completeness of this document. However, as ongoing development efforts are continually improving the capabilities of our products, we cannot guarantee the accuracy of the contents of this document. We disclaim liability for errors, omissions, or future changes. The absence of a product or service name, slogan, or logo does not constitute a waiver of any trademark or other intellectual property rights relating to that name, slogan, or logo owned by Fujitsu Computer Systems Corporation, its parent, subsidiaries, and affiliated companies.

Fujitsu, the Fujitsu logo, and LifeBook are registered trademarks of Fujitsu Limited.

Intel is a registered trademark and Core is a trademark of Intel Corporation or its subsidiaries in the United States and other countries.

ATI and Radeon are trademarks of Advanced Micro Devices, Inc.

The ExpressCard word mark and logo are owned by the Personal Computer Memory Card International Association (PCMCIA) and any use of such marks by Fujitsu Computer Systems Corporation is under license.

Windows, Windows Vista, and ReadyBoost are either registered trademarks or trademarks of Microsoft Corporation in the United States and/or other countries.

PCMCIA is a trademark of the Personal Computer Memory Card International Association.

Google and Picasa are trademarks or registered trademarks of Google Incorporated.

Blu-ray™ and Blu-ray Disc® are trademarks or registered trademarks of Sony Corporation in the United States and other countries.

EverNote is a trademark of EverNote LLC in the United States and other countries.

Memory Stick and Memory Stick Duo are trademarks of Sony, its parent, and/or its affiliates.

OmniPass is a trademark of Softex, Inc.

Adobe, Acrobat, and Acrobat Reader are either registered trademarks or trademarks of Adobe Systems, Incorporated in the United States and/or other countries.

Quicken is a registered trademark and/or registered service mark of Intuit, Inc. or one of its subsidiaries in the United States and other countries.

Roxio is a trademark of Roxio, a division of Sonic Solutions.

Norton Internet Security is a trademark of Symantec Corporation in the United States and other countries.

PowerProducer, MakeDisc, PowerDVD, and PowerDirector are trademarks of CyberLink Corp.

This product incorporates copyright protection technology that is protected by method claims of certain U.S. patents and other intellectual property rights owned by Macrovision Corporation and other rights owners. Use of this copyright protection technology must be authorized by Macrovision Corporation, and is intended for home and other limited viewing uses only unless otherwise authorized by Macrovision Corporation. Reverse engineering or disassembly is prohibited.

All other trademarks mentioned herein are the property of their respective owners.

Warning



Handling the cord on this product will expose you to lead, a chemical known to the State of California to cause birth defects or other reproductive harm.

Wash hands after handling.

© Copyright 2007 Fujitsu Computer Systems Corporation. All rights reserved. No part of this publication may be copied, reproduced, translated, stored, or transmitted in any electronic form without the written consent of Fujitsu Computer Systems Corporation. B5FJ-4161-01EN-00



DECLARATION OF CONFORMITY

according to FCC Part 15

Responsible Party Name: Fujitsu Computer Systems Corporation

Address: 1250 E. Arques Avenue (M/S 122)
Sunnyvale, CA 94085

Telephone: (408) 746-6000

Declares that product: Model Configuration: LifeBook N6460
Complies with Part 15 of the FCC Rules.

This device complies with Part 15 of the FCC rules. Operations are subject to the following two conditions: (1) This device may not cause harmful interference, (2) This device must accept any interference received, including interference that may cause undesired operation.

IMPORTANT SAFETY INSTRUCTIONS

This product requires an AC adapter to operate. Use only a UL Listed I.T.E. AC Adapter with an output rating of 19V DC, with a current of 5.27A (100W).

AC adapter output polarity:



When using your notebook equipment, basic safety precautions should always be followed to reduce the risk of fire, electric shock and injury to persons, including the following:

- Do not use this product near water for example, near a bathtub, washbowl, kitchen sink or laundry tub, in a wet basement or near a swimming pool.
- Avoid using the modem during an electrical storm. There may be a remote risk of electric shock from lightning.
- Do not use the modem to report a gas leak in the vicinity of the leak.
- Use only the power cord and batteries indicated in this manual. Do not dispose of batteries in a fire. They may explode. Check with local codes for possible special disposal instructions.
- To reduce the risk of fire, use only No. 26 AWG or larger UL Listed or CSA Certified Telecommunication Line Cord.
- For TV tuner use: To protect from overvoltages and transients on the Cable Distribution System, make sure that the outer shield of the coaxial cable is connected to earth (grounded) at the building premise as close to the point of cable entrance as practicable, as required per NEC Article 820.93, ANSI/NFPA 70: 2005. If you have questions about your CATV installation, contact your service provider.

SAVE THESE INSTRUCTIONS

For Authorized Repair Technicians Only



Danger of explosion if Lithium (clock) battery is incorrectly replaced. Replace only with the same or equivalent type recommended by the manufacturer. Dispose of used batteries according to the manufacturer's instruction.



For continued protection against risk of fire, replace only with the same type and rating fuse.

System Disposal



LAMP(S) INSIDE THIS PRODUCT CONTAIN MERCURY AND MUST BE RECYCLED OR DISPOSED OF ACCORDING TO LOCAL, STATE, OR FEDERAL LAWS.

RECYCLING YOUR BATTERY

Over time, the batteries that run your mobile computer will begin to hold a charge for a shorter amount of time; this is a natural occurrence for all batteries. When this occurs, you may want to replace the battery with a fresh one*. If you replace it, it is important that you dispose of the old battery properly because batteries contain materials that could cause environmental damage if disposed of improperly.



Fujitsu is very concerned with environmental protection, and has enlisted the services of the Rechargeable Battery Recycling Corporation (RBRC)**, a non-profit public service organization dedicated to protecting our environment by recycling old batteries at no cost to you.

RBRC has drop-off points at tens of thousands of locations throughout the United States and Canada. To find the location nearest you, go to www.RBRC.org or call 1-800-822-8837.

If there are no convenient RBRC locations near you, you can also go to the EIA Consumer Education Initiative website (<http://EIAE.org/>) and search for a convenient disposal location.

Remember – protecting the environment is a cooperative effort, and you should make every effort to protect it for current and future generations.

* To order a new battery for your Fujitsu mobile computer, go to the Fujitsu shopping site at www.shopfujitsu.com in the US or www.fujitsu.ca/products/notebooks in Canada.

** RBRC is an independent third party to which Fujitsu provides funding for battery recycling; RBRC is in no way affiliated with Fujitsu.

Fujitsu LifeBook® N6400 Series

Table of Contents

1

PREFACE

About This Guide	3
Fujitsu Contact Information	3
Warranty	3

2

GETTING TO KNOW YOUR LIFEBOOK NOTEBOOK

Overview

Unpacking	7
---------------------	---

Locating the Controls and Connectors

Top and Front Components	8
Left-Side Panel Components	10
Right-Side Panel Components	11
Rear Panel Components	12
Bottom Components	14

Status Indicator Panel

Battery Charging Indicator	15
Battery Status Indicator	15
Hard Drive/Optical Drive Access Indicator	15
Email Indicator	15
NumLock Indicator	15
CapsLock Indicator	15
ScrLock Indicator	15

Keyboard

Using the Keyboard	16
Numeric Keypad	16
Windows Keys	16
Cursor Keys	16
Function Keys	17

Volume Control

Controlling the Volume	18
----------------------------------	----

Touchpad Pointing Device

Clicking	19
Double-Clicking	19
Dragging	20
Scrolling	20
Touchpad Control Adjustment	20

Application/Media Player Panel

Mode Button	21
Application Launch/Media Player Buttons	21
Configuring your Application Panel	21
Using the Media Player Buttons	22
Using the Visual Optimizer	22

3

GETTING STARTED

Power Sources

Connecting the AC Adapter	25
-------------------------------------	----

Display Panel

Opening the Display Panel	26
Adjusting Display Panel Brightness	26
Closing the Display Panel	26

Starting Your LifeBook Notebook

Power On	27
Boot Sequence	27
Hard Disk Drive Passwords	27
BIOS Setup Utility	27
Booting the System	28
Starting Windows Vista the first time	28
Registering Your LifeBook notebook	29
Installing Click Me!	29
Fujitsu Driver Update Utility	29

Power Management

Power and Suspend/Resume Button	30
Sleep Mode	30
Hibernation (Save-to-Disk) Feature	31
Windows Power Management	31
Restarting the System	31
Power Off	31

4

USER-INSTALLABLE FEATURES

Memory Stick/SD/xD Card Slot

Inserting Memory Stick/SD/xD Cards	35
Removing Memory Stick/SD/xD Cards	36

Lithium ion Battery

Recharging the Batteries	37
Replacing the Battery	38

Optical Drive

Optical Drive Software	39
Loading Media	39
Removing Media	39
Emergency Optical Drive Tray Release	40
Playing Media on the Optical Drive	40
Using the Optical Player Software	40
Using the Drive on Battery Power	40
Auto Insert Notification Function	41

Hard Disk Drive

Formatting the Hard Disk Drive	42
--	----

PC Cards/ExpressCards™

Installing PC Cards	43
Removing PC Cards	43
Installing ExpressCards	44
Removing ExpressCards	44

Memory Upgrade Module

Installing a Memory Module	45
Removing a Memory Upgrade Module	46
Checking the Memory Capacity	46
Enabling/Disabling Turbo Memory	46

Device Ports

Communications Ports	47
LAN Port	47
IEEE 1394 Jack	47
HDMI Port	47
Universal Serial Bus (USB) 2.0 Ports	48
S-Video Out Port	48
Microphone Jack	48
Headphone/SPDIF Jack	48
External Video Port	49

5

TROUBLESHOOTING

Identifying the Problem	53
Specific Problems	54
Troubleshooting Table	54
Power On Self Test Messages	61
Modem Result Codes	62

Restoring Pre-installed Software

Restoring the Factory Image	63
Automatically Downloading Driver Updates	64

6

CARE AND MAINTENANCE

LifeBook Notebook	67
Batteries	68
Floppy Disks and Drives	68
DVDs and CDs	68
PC Cards/ExpressCards	69

7

SYSTEM SPECIFICATIONS

Configuration Label	73
Microprocessor	73
Memory	73
Video	73
Audio	73
Mass Storage Devices	73
Features	74
Device Ports	74
Power	74
Dimensions	74
Environmental Requirements	74
Popular Accessories	75
Pre-Installed Software	75
Learning About Your Software	75

8

GLOSSARY/REGULATORY

Glossary	77
Regulatory Information	83

APPENDIX A: INTEGRATED WIRELESS LAN USER'S GUIDE

Before Using the Wireless LAN

Wireless LAN Modes Using this Device	88
Deactivating the WLAN Device	89
Activating the WLAN Device	89
Configuring the WLAN	90
Connecting to a Network	90

Troubleshooting the WLAN

Troubleshooting Table	91
---------------------------------	----

Wireless LAN Glossary

Glossary	92
--------------------	----

IP address information

About IP Addresses	94
------------------------------	----

WLAN Specifications

Specifications	95
--------------------------	----

APPENDIX A: USING THE FINGERPRINT SENSOR

Introducing the Fingerprint Sensor Device	99
Getting Started	99
Installing OmniPass	99
User Enrollment	100
Using OmniPass	101
Configuring OmniPass	103
OmniPass Control Center	104
Troubleshooting	105

INDEX

Index	107
-----------------	-----



1
Preface

Preface

ABOUT THIS GUIDE

The LifeBook® N6460 notebook from Fujitsu Computer Systems Corporation provides desktop performance with a fast Intel® Core™ 2 Duo processor. The 17" Color Enhanced Crystal View WXGA+ high-resolution screen displays vibrant colors with pinpoint sharpness. The LifeBook features an ATI Mobility™ Radeon™ HD 2600 graphics chipset with 512 MB of HyperMemory™*.

It comes with Microsoft® Windows Vista™ Home Premium, Windows Vista Business, or Windows Vista Ultimate pre-installed.

This manual explains how to operate your LifeBook notebook's hardware and built-in system software.

Conventions Used in the Guide

Keyboard keys appear in brackets.

Example: [Fn], [F1], [ESC], [ENTER] and [CTRL].

Pages with additional information about a specific topic are cross-referenced within the text.

Example: (See page xx.)

On screen buttons or menu items appear in bold

Example: Click **OK** to restart your LifeBook notebook.



The information icon highlights information that will enhance your understanding of the subject material.



The caution icon highlights information that is important to the safe operation of your computer or to the integrity of your files. Please read all caution information carefully.



The warning icon highlights information that can be hazardous to either you, your notebook, or your files. Please read all warning information carefully.

* *HyperMemory™ is the cumulative total of dedicated and system memory used by the Graphics Processing Unit (GPU) intended for use in the processing and creation of 3D and other images. The HD 2600 chipset with 512 MB of HyperMemory has 256 MB dedicated VRAM and 256 MB shared system memory.*

FUJITSU CONTACT INFORMATION

Service and Support

You can contact Fujitsu Service and Support the following ways:

- Toll free: 1-800-8FUJITSU (1-800-838-5487)
- E-mail: 8fujitsu@us.fujitsu.com
- Website:
http://www.computers.us.fujitsu.com/support

Before you place the call, you should have the following information ready so that the customer support representative can provide you with the fastest possible solution:

- Product name
- Product configuration number
- Product serial number
- Purchase date
- Conditions under which the problem occurred
- Any error messages that have occurred
- Type of device connected, if any

Fujitsu Online

You can go directly to the online Fujitsu Product catalog for your LifeBook notebook by going to:

www.shopfujitsu.com.



You must have an active internet connection to use the on-line URL links.

To ensure that you always have the most current driver updates related to your system, you should occasionally access the Fujitsu Driver Update (FDU) utility. With FDU, you can choose to automatically or manually go to the Fujitsu site to check for new updates for your system.

The FDU icon should appear in the system tray at the bottom right of your screen (roll the cursor over the icons to find the correct one). If the FDU icon does not appear in the system tray, it can be started by going to [Start] -> All Programs, and clicking on Fujitsu Driver Update; this will create the icon automatically.

WARRANTY

Depending upon the configuration of your LifeBook notebook, your system is backed by either a one-year or three-year International Limited Warranty. Check the information that came with your LifeBook notebook for further warranty terms and conditions.



2

Getting to Know Your LifeBook Notebook



Figure 2-1. LifeBook N6460 Notebook

Overview

This section describes the components of your Fujitsu LifeBook N6460 notebook. We strongly recommend that you read it before using your LifeBook notebook, even if you are already familiar with notebook computers.

UNPACKING

When you receive your LifeBook notebook, unpack it carefully, and compare the parts you have received with the items listed below.

For a pre-configured model you should have:

- LifeBook N6460 notebook computer
- Lithium ion battery, pre-installed
- AC adapter with AC power cord (Figure 2-2)
- Phone/Modem (RJ-11) telephone cable
- Drivers and Applications Restore CD
- Recovery and Utility Disc
- Getting Started Guide
- User's Guide (this guide)
- International Limited Warranty Brochure
- Microsoft-associated materials

Depending upon the configuration of your system, one or more of the following items may also be included in the box:

- Application CDs for third-party software
- Additional battery
- Remote control package, including remote control, infrared remote control receiver, infrared control cable (available with Windows Vista™ Home Premium only)
- ExpressCard Hybrid TV Tuner

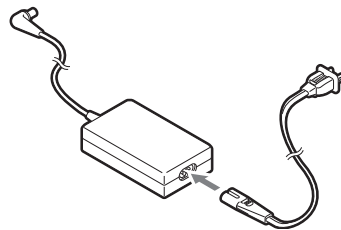

Figure 2-2. AC Adapter

Locating the Controls and Connectors

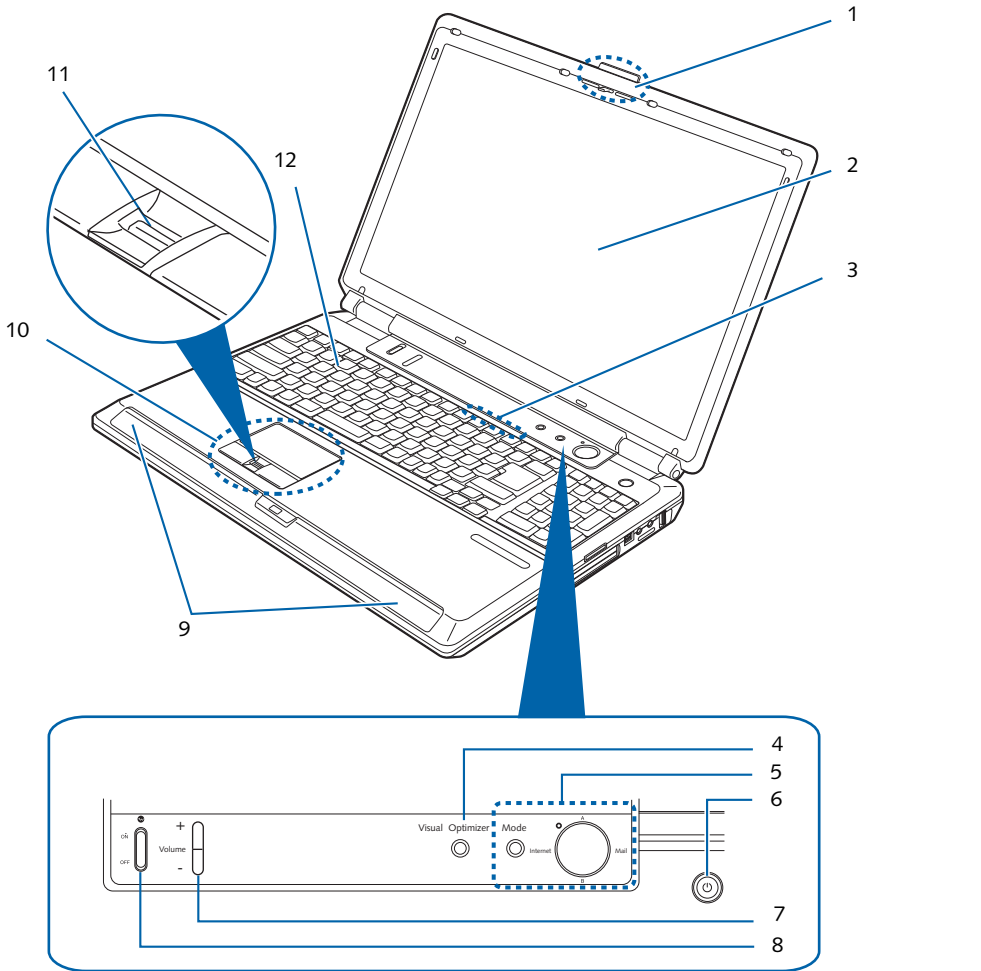

Figure 2-3. LifeBook notebook, display open

- | | |
|------------------------------------|-----------------------------------|
| 1 Display Panel Latch | 7 Volume Control |
| 2 Display Panel | 8 Wireless LAN Switch |
| 3 Status Indicator Panel | 9 Stereo Speakers |
| 4 Visual Optimizer Button | 10 Touchpad Pointing Device |
| 5 Application/Media Player Buttons | 11 Fingerprint Recognition Sensor |
| 6 Power/Suspend/Resume Button | 12 Keyboard |

TOP AND FRONT COMPONENTS

The following is a brief description of your LifeBook notebook's top and front components.

Display Panel Latch

The display panel latch locks and releases the display panel.

Display Panel

The display panel is a color LCD panel with back lighting for the display of text and graphics.

Status Indicator Panel

The Status Indicator Panel displays symbols that correspond with a specific component of your LifeBook notebook. (See *Status Indicator Panel* on page 15 for more information)

Visual Optimizer Button

Enriches colors while in video mode and enhances text when viewing static web pages. (See *Using the Visual Optimizer* on page 22 for more information)

Application/Media Player Buttons

The LifeBook Application/Media Player buttons allow you to control the media player when your unit is on and to launch specified applications with the touch of a button. Note that if you are using the optional remote control, it overrides these buttons; the media buttons do not work while Media Center Edition is running. (See *LifeBook Application/Media Player Panel on page 21 for more information*)

Power/Suspend/Resume Button

The Power/Suspend/Resume button allows you to suspend notebook activity without powering off, resume your notebook from Sleep mode, and power on your LifeBook notebook when it has been shut down. (See *Power On on page 27 for more information*) and (See *Power and Suspend/Resume Button on page 30 for more information*)

Volume Control

The Volume Control toggle allows you to increase or decrease volume manually. (See *Controlling the Volume on page 18 for more information*)

Wireless LAN Switch

The Wireless LAN On/Off Switch turns the wireless LAN on and off. (See *Integrated Wireless LAN* User's Guide on page 85 for more information*)

Stereo Speakers

The built-in boxless dual speakers provide stereo sound. Additionally, there is a subwoofer located on the bottom of the system. (See *Bottom Components on page 14 for more information*)

Touchpad Pointing Device

The pointing device is a Touchpad that allows you simple cursor control. (See *Touchpad Pointing Device on page 19 for more information*)

Fingerprint Recognition Sensor

The fingerprint recognition sensor allows you to increase the security of your system by having it "recognize" your unique fingerprint. (See *Fingerprint Sensor Device on page 99 for more information*)

The fingerprint recognition sensor can also be used as a scrolling button that lets you navigate quickly through a document without having to use the window scroll bars. (See *Scrolling on page 20 for more information*)

Keyboard

A full-size keyboard with dedicated Windows keys and 10-key keypad. (See *Using the Keyboard on page 16 for more information*)

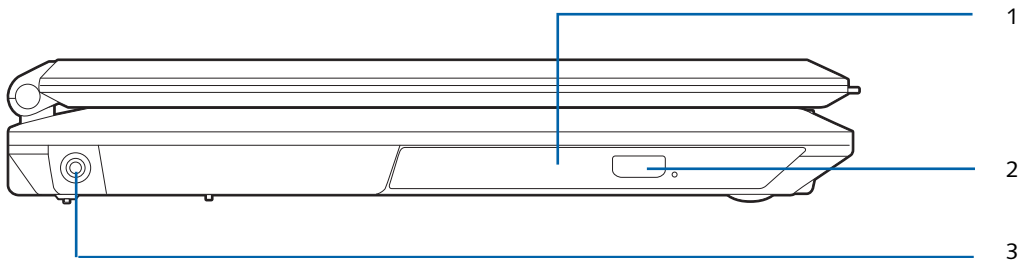

Figure 2-4. LifeBook notebook left-side panel

- 1 Optical Drive
- 2 Optical Drive Eject Button
- 3 DC Power Jack

LEFT-SIDE PANEL COMPONENTS

Following is a brief description of your LifeBook notebook's left-side components.

Optical Drive

One of several different drives can be installed depending upon the configuration of your system. (*See Optical Drive on page 39 for more information*).

Optical Drive Eject Button

The optical drive eject button is used to eject the media tray.

DC Power Jack

The DC power jack allows you to plug in the AC adapter to power your LifeBook notebook and charge the internal Lithium ion battery.

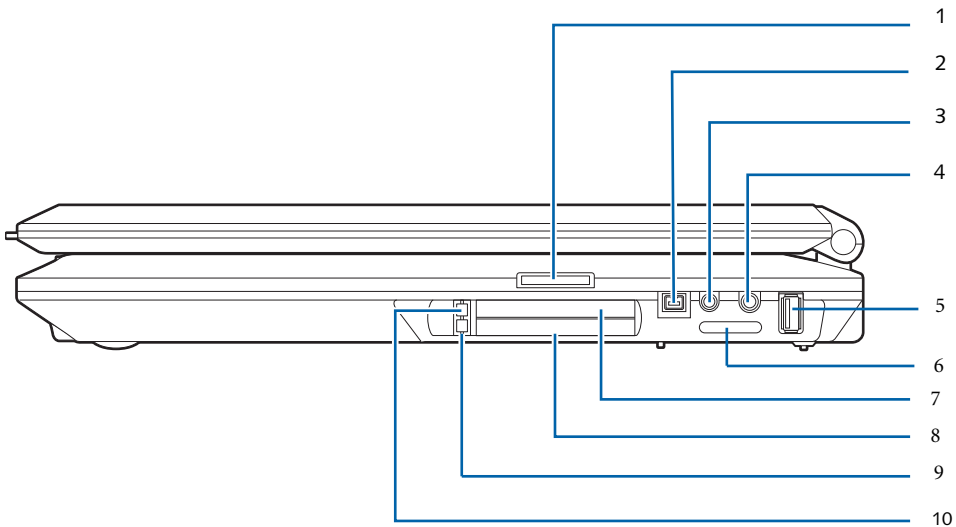

Figure 2-5. LifeBook notebook right-side panel

- | | |
|--------------------------------|---------------------------------|
| 1 Memory Stick/SD/xD Card Slot | 6 Subwoofer Speaker Air Chamber |
| 2 IEEE1394 Port | 7 ExpressCard Slot |
| 3 Headphone Jack | 8 PC Card Slot |
| 4 Microphone Jack | 9 PC Card Eject Button |
| 5 USB 2.0 Port | 10 ExpressCard Eject Button |

RIGHT-SIDE PANEL COMPONENTS

Following is a brief description of your LifeBook notebook's right-side components.

Memory Stick/SD/xD Card Slot

The Memory Stick/Secure Digital (SD)/xD card slot allows you to insert a flash memory card for data storage. This architecture allows you to transfer data between a variety of different digital devices. (See *Inserting Memory Stick/SD/xD Cards on page 35 for more information*)

IEEE 1394 Port

The IEEE 1394 port is used to connect Firewire devices (such as digital cameras) to your LifeBook notebook. (See *IEEE 1394 Jack on page 47 for more information*)

Headphone/SPDIF Jack

The headphone/SPDIF audio jack allows you to connect headphones or powered external speakers, or to download digital audio onto a MiniDisc recorder's SPDIF (Sony Philips Digital Interface) format. (See *Headphone/SPDIF Jack on page 48 for more information*)

Microphone Jack

The microphone jack allows you to connect an external stereo microphone. (See *Microphone Jack on page 48 for more information*)

USB 2.0 Ports

The five USB ports (one on the right side panel and four on the rear panel) allow you to connect Universal Serial

Bus (USB) 2.0 or USB 1.1 devices. (See *Universal Serial Bus (USB) 2.0 Ports on page 48 for more information*).

Windows Vista Users: All USB ports can be used to connect an infrared remote control receiver that is required when using the optional Media Center Edition remote control. If you have Windows Vista installed, please change the setting of "Wake up by USB device" on "Windows Mobility Center from Disable to Enable.

ExpressCard Slot

The ExpressCard Slot allows you to insert an ExpressCard. (See *PC Cards/ExpressCards™ on page 43 for more information*)

PC Card Slot

The PC Card Slot allows you to insert a Type I or Type II PC Card. (See *PC Cards/ExpressCards™ on page 43 for more information*)

PC Card Eject Button

The PC Card eject buttons are used to eject a PC Card from the PC Card slot. (See *PC Cards/ExpressCards™ on page 43 for more information*)

ExpressCard Eject Button

The ExpressCard eject buttons are used to eject an ExpressCard from the ExpressCard slot. (See *PC Cards/ExpressCards™ on page 43 for more information*)

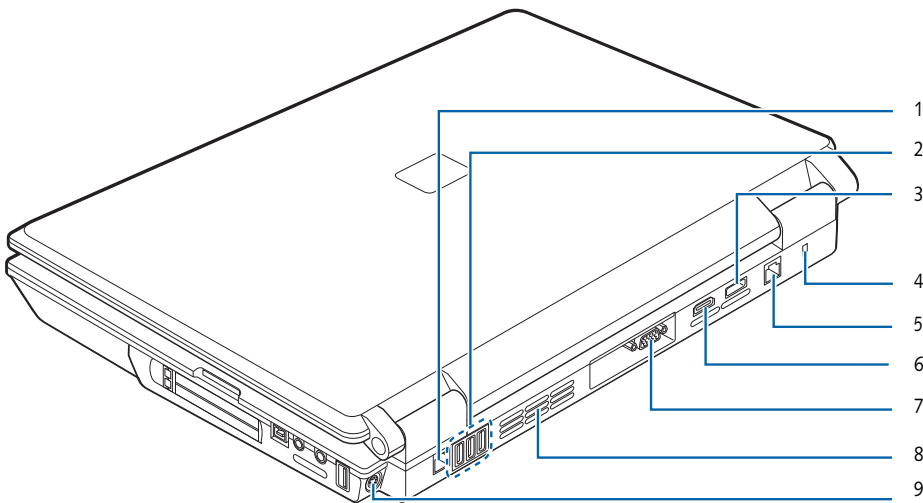

Figure 2-6. LifeBook notebook back panel

- | | |
|--------------|-----------------------|
| 1 LAN Port | 6 HDMI Port |
| 2 USB Ports | 7 External Video Port |
| 3 USB Port | 8 Air Vents |
| 4 Lock Slot | 9 S-Video Out Port |
| 5 Modem Port | |

REAR PANEL COMPONENTS

Following is a brief description of your LifeBook notebook's rear panel components.

LAN Port

The LAN port is designed to accept a Local Area Network (LAN) RJ-45 jack. (See *Communications Ports on page 47 for more information*)

USB 2.0 Ports

The five USB ports (one on the right side panel and four on the rear panel) allow you to connect Universal Serial Bus (USB) 2.0 or USB 1.1 devices. (See *Universal Serial Bus (USB) 2.0 Ports on page 48 for more information*). All USB ports can be used to connect an infrared remote control receiver that is required when using the optional Media Center Edition remote control. If you have Windows Vista installed, please change the setting of "Wake up by USB device" on "Windows Mobility Center" from Disable to Enable.

Anti-theft Lock Slot

The anti-theft lock slot allows you to attach an optional physical lock down device.

Modem Port

The modem port is designed to accept a Modem (RJ-11) telephone jack for the multi-national internal 56K modem. (See *Communications Ports on page 47 for more information*)



The internal modem is not intended for use with Digital PBX systems. Do not connect the modem to a digital PBX as it may cause serious damage to the internal modem or your LifeBook notebook. Consult your PBX manufacturer's documentation for details. Some hotels have Digital PBX systems. Be sure to find out BEFORE you connect your modem. Third-party hardware is available to allow modem-to-PBX interface.



The internal modem is designed to the ITU-T V.90 standard. Its maximum speed of 53000bps is the highest allowed by FCC, and its actual connection rate depends on the line conditions. The maximum upload speed is 33600bps.

HDMI Port

The HDMI port is used to connect compatible digital devices with your computer (such as video game console, set-top box, or AV receiver). (See *HDMI Interface on page 48 for more information*)

External Video Port

The external video port allows you to connect an external monitor or LCD projector. (See *External Video Port on page 49 for more information*)

Air Flow Vents

The air flow vents assist in proper cooling of the system.



To protect your notebook from damage and to optimize system performance, be sure to **keep all air all vents unobstructed, clean, and clear of debris**. This may require periodic cleaning, depending upon the environment in which the system is used.

Do not operate the notebook in areas where the air vents can be obstructed, such as in tight enclosures or on soft surfaces like a bed or cushion.

S-Video Out Port

The S-Video out port is used to transmit a high resolution video signal to a compatible TV or VCR.
(See *S-Video Out Port* on page 48 for more information)

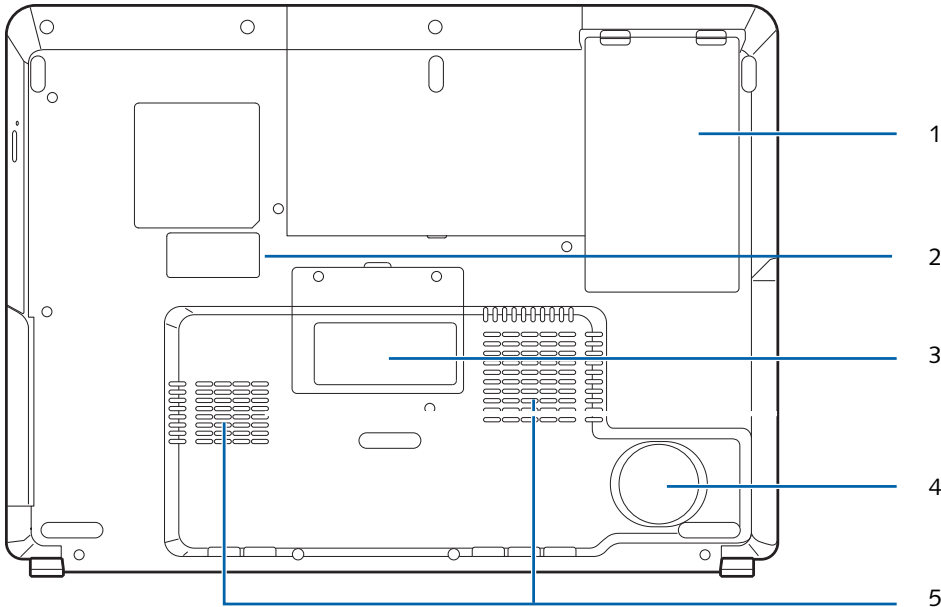

Figure 2-7. LifeBook notebook bottom panel

- 1 Lithium ion Battery Bay
- 2 Configuration Label (approximate location)
- 3 Memory Compartment Cover
- 4 Subwoofer
- 5 Air Flow Vents

BOTTOM COMPONENTS

Following is a brief description of your LifeBook notebook's bottom panel components.

Lithium ion Battery Bay

The battery bay contains the internal Lithium ion battery. It can be opened for the removal of the battery when stored over a long period of time or for swapping a discharged battery with a charged Lithium ion battery. (See *Lithium ion Battery* on page 37 for more information)

Memory Compartment Cover

Your LifeBook notebook comes with high speed DDR2-667 PC5300 SO-DIMM memory. The memory upgrade compartment allows you to expand the system memory capacity of your LifeBook notebook, thus improving overall performance. (See *Memory Upgrade Module* on page 45 for more information)

Subwoofer

The subwoofer speaker provides bass-range sound to supplement the stereo speakers, resulting in high-quality audio.

Air Flow Vents

The air flow vents assist in proper cooling of the system.



To protect your notebook from damage and to optimize system performance, be sure to **keep all air vents unobstructed, clean, and clear of debris**. This may require periodic cleaning, depending upon the environment in which the system is used.

Do not operate the notebook in areas where the air vents can be obstructed, such as in tight enclosures or on soft surfaces like a bed or cushion.

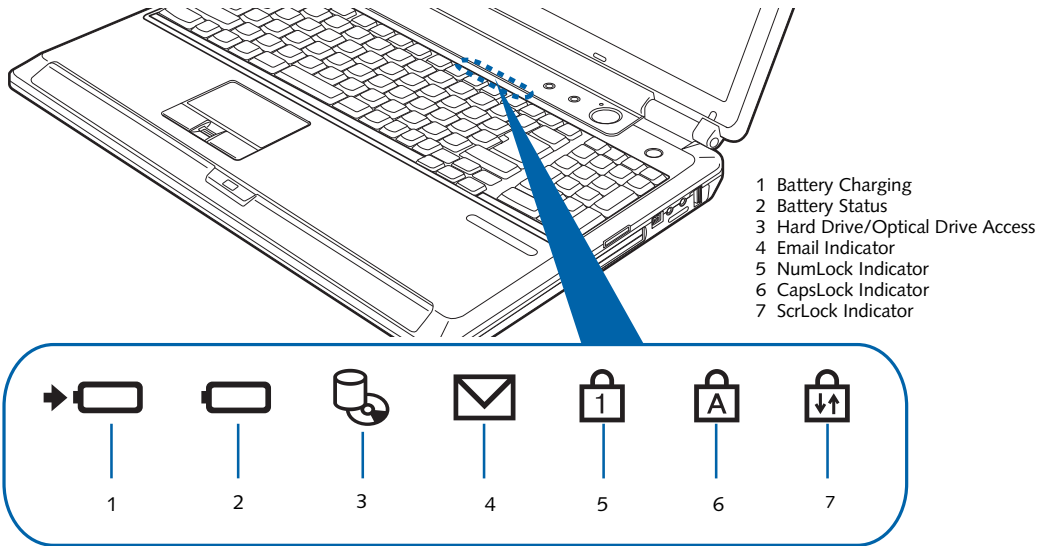

Figure 2-8. Status Indicator Panel/Volume LEDs

Status Indicator Panel

The Status Indicator panel is located on the front of the palm rest, just below the latch point. Within this panel are symbols that correspond to specific components of your LifeBook notebook. These symbols tell you how each of those components is operating. (Figure 2-8)

BATTERY CHARGING INDICATOR

The Battery Charging indicator displays whether or not the Lithium ion battery is currently being charged.

LED Condition	Charging Status of Battery
Green, solid	Fully charged or no battery installed.
Orange, solid	Being charged
Orange, blinking	Charging suspended because battery temperature too high.
Off	Not charging because AC adapter is not connected.

BATTERY STATUS INDICATOR

This indicator shows how much charge is available within the installed battery.

LCD Condition	Battery Charge Level
Green, solid	Between 50% and 100% charged
Orange, solid	Between 13% and 49% charged
Red, solid	Between 0% and 12% charged
Red, blinking	There is a problem with the battery
Off	No battery is installed or the system is shut off.

HARD DRIVE/OPTICAL DRIVE ACCESS INDICATOR

The Hard Drive/Optical Drive Access indicator states whether your internal hard drive or optical drive are being accessed.

EMAIL INDICATOR

The Email indicator shows that you have received new email.

NUMLOCK INDICATOR

The NumLock indicator shows that the internal keyboard is set in ten-key numeric keypad mode.

CAPSLOCK INDICATOR

The CapsLock indicator shows that your keyboard is set to type in all capital letters.

SCRLOCK INDICATOR

The ScrLock indicator shows that your scroll lock is active.

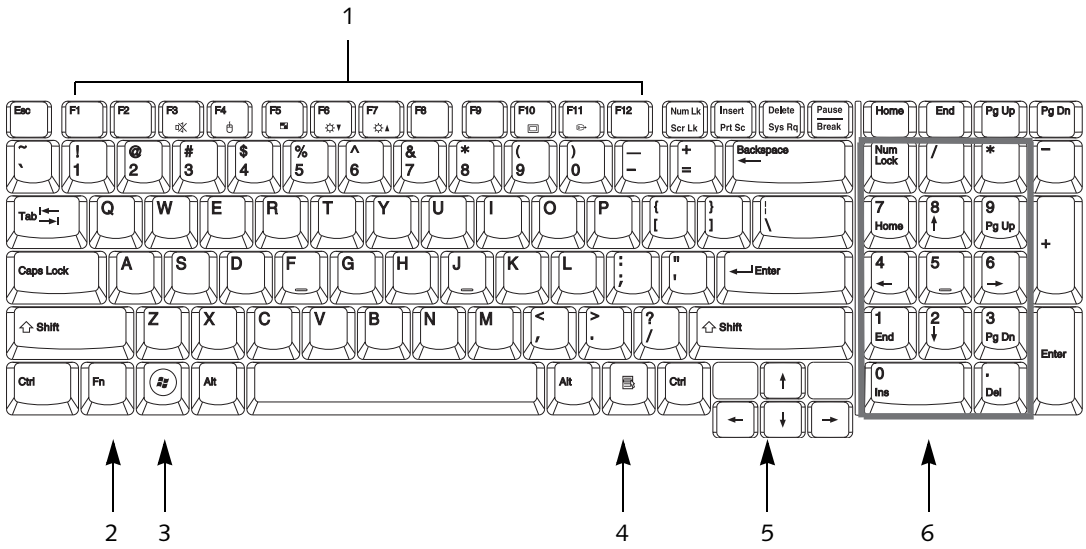

Figure 2-9. Keyboard

- 1 Function Keys
- 2 [Fn] Key
- 3 Start Key
- 4 Application Key
- 5 Cursor Keys
- 6 Numeric Keypad (surrounded by thick gray line)

Keyboard

USING THE KEYBOARD

Your Fujitsu LifeBook notebook has an integrated 103-key keyboard. The keys perform all the standard functions of a keyboard, including the Windows keys and other special function keys. This section describes the following keys.

- **Numeric keypad:** Your LifeBook notebook has a ten-key numeric keypad which allows certain keys to serve dual purposes, both as numeric/mathematical keys and navigation keys. The ability to toggle between the numerical keys and navigation keys is controlled through the [NumLk] key.
- **Cursor keys:** Your keyboard contains four arrow keys for moving the cursor or insertion point to the right, left, up, or down within windows, applications and documents.
- **Function keys:** The keys labeled [F1] through [F12] are used in conjunction with the [Fn] key to produce special actions that vary depending on what program is running.
- **Windows keys:** These keys work with your Windows operating system and function the same as the onscreen Start menu button, or the right button on your pointing device.

NUMERIC KEYPAD

The right-hand section of the keyboard serves as a numeric keypad. To activate the keypad functions, press the [NumLk] button. Using the keypad keys, you can enter numerals 0 through 9, perform addition (+), subtraction (-), multiplication (*), or division (/), and enter decimal points (.) using the keys designated as ten-key function keys. When [NumLk] is not active, you can use the numeric keypad to navigate (Home, End, Page Up, Page Down, left, right, up, down). The keys in the numeric keypad are marked on the front edge of the key to indicate their secondary functions.

WINDOWS KEYS

Your notebook has two Windows keys: a Start key and an Application key. The Start key displays the Start menu, and functions the same as your onscreen Start menu button. The Application key functions the same as your right mouse button and displays shortcut menu for the selected item. (Refer to your Windows documentation for more information regarding the Windows keys.)







CURSOR KEYS

The cursor keys are the four arrow keys on the keyboard which allow you to move the cursor up, down, left and right in applications. In programs such as Windows Explorer, it moves the “focus” (selects the next item up, down, left, or right).

FUNCTION KEYS

Your LifeBook notebook has 12 function keys, F1 through F12. The functions assigned to these keys differ for each application. You should refer to your software documentation to find out how these keys are used.

The [Fn] key provides extended functions for the notebook and is always used in conjunction with another key.

Icon	Keys	Description
	[Fn+F3]	Pressing [F3] while holding [Fn] will toggle the Audio Mute on and off.
	[Fn+F4]	Pressing [F4] while holding [Fn] will toggle the touchpad on and off. (This function key combination only works if the BIOS setting for Advanced -> Keyboard/Mouse Features -> Internal Pointing Device is set to Manual Setting.)
	[Fn+F6]	Pressing [F6] repeatedly while holding [Fn] will lower the brightness of your display.
	[Fn+F7]	Pressing [F7] repeatedly while holding [Fn] will increase the brightness of the display.
	[Fn+F8]	Pressing [F8] repeatedly while holding [Fn] will lower the volume of your system.
	[Fn+F9]	Pressing [F9] repeatedly while holding [Fn] will increase the volume of your system.
	[Fn+F10]	Pressing [F10] while holding [Fn] allows you to change your selection of where to send your display video. Each time you press the key combination you will step to the next choice. The choices, in order, are: built-in display panel only, external device only, and both built-in display panel and external devices.

Volume Control

Your LifeBook notebook has multiple volume controls which interact with each other.



Any software that contains audio files will also contain a volume control of its own. If you install an external audio device that has an independent volume control, the hardware volume control and the software volume control will interact with each other. It should be noted that if you set your software volume to Off, you will override the external volume control setting.

CONTROLLING THE VOLUME

Methods to Control Volume

The volume can be controlled in several ways:

- Volume can be set using the volume control toggle on the right of the WLAN switch.

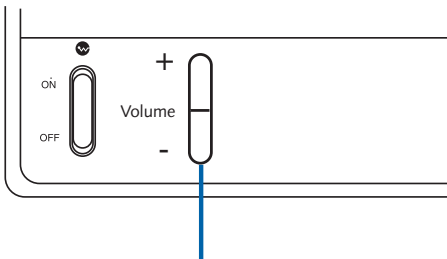

Volume Control

Figure 2-10 Volume Control

- Volume can be set from within the Volume Control in the system tray.
- Volume can be controlled by many volume controls that are set within individual applications.
- Certain external audio devices you might connect to your system may have hardware volume controls.

Each source discussed above puts an upper limit on the volume level that must then be followed by the other sources.

We recommend that you experiment with the various volume controls to discover the optimal sound level.

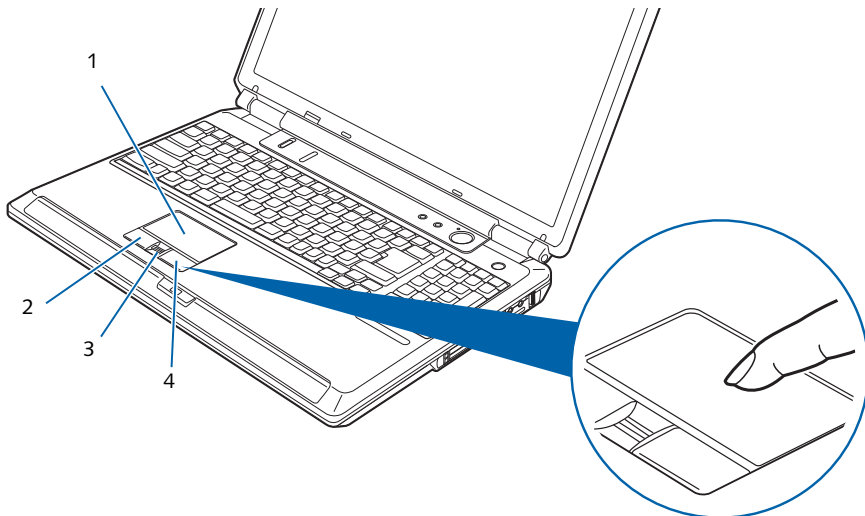

Figure 2-11. Touchpad Pointing Device

1 Cursor Control
2 Left Button

3 Fingerprint Recognition
Sensor/Scroll Button
4 Right Button

Touchpad Pointing Device

The Touchpad pointing device is built into your notebook. It is used to control the movement of the pointer to select items on your display panel. The Touchpad is composed of a cursor control, a left and right button, and an up-and-down scroll button (which also acts as a fingerprint recognition sensor).

The cursor control works the same way a mouse does, and moves the cursor around the display. It only requires light pressure with the tip of your finger, and the more pressure you use, the faster the cursor will move.

The left and right buttons function the same as mouse buttons. The actual functionality of the buttons may vary depending on the application that is being used. The up-and-down scroll button allows you to quickly navigate up and down a screen. For information on using the scroll button as a fingerprint recognition sensor, refer to “Fingerprint Sensor Device” on page 99



An external mouse can be connected to the USB port on your notebook, and be used simultaneously with the Touchpad. However, if you boot the system with an external mouse connected the Touchpad will be disabled or enabled depending on your BIOS settings. (See *BIOS Setup Utility* on page 27 for more information)

CLICKING

Clicking means pushing and releasing a button. To left-click, move the cursor to the item you wish to select, press the left button once, and then immediately release it. To right-click, move the mouse cursor to the item you wish to select, press the right button once, and then immediately release it. You also have the option to perform the clicking operation by tapping lightly on the Touchpad once. (Figure 2-12)

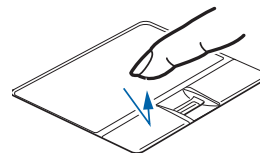

Figure 2-12. Clicking

DOUBLE-CLICKING

Double-clicking means pushing and releasing the left button twice in rapid succession. This procedure does not function with the right button. To double-click, move the cursor to the item you wish to select, press the left button twice, then immediately release it. You also have the option to perform the double-click operation by tapping lightly on the Touchpad twice. (Figure 2-13)



Figure 2-13. Double-clicking



If the interval between clicks is too long, the double-click will not be executed. The interval length can be changed by going to Control Panel -> Mouse -> Mouse Properties -> Buttons tab.

DRAGGING

Dragging means pressing and holding the left button, while moving the cursor. To drag, move the cursor to the item you wish to move. Press and hold the left button while moving the item to its new location and then release it. (Figure 2-14)

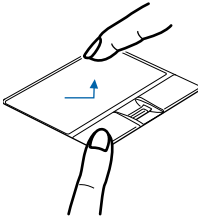

Figure 2-14. Dragging

SCROLLING

Using the scrolling sensor allows you to navigate through a document quickly without using the window's scroll bars. This is particularly useful when you are navi-

gating through online pages. To use the scrolling sensor, move your finger forward or backward across the button to scroll up or down a page. When you have reached the desired section of the page, raise your finger.

Note that you can also scroll by sliding your finger up and down the right side of the touchpad. This feature is disabled by default, but you can enable it by going to Start -> Control Panel -> Mouse.

The scrolling sensor is also used as a fingerprint sensor. (See *Fingerprint Sensor Device on page 99 for more information*)

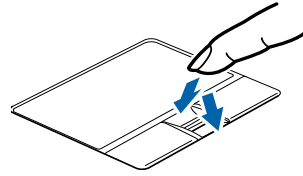

Figure 2-15. Scrolling

TOUCHPAD CONTROL ADJUSTMENT

The Windows Control Panel allows you to customize your Touchpad with selections made from within the Mouse Properties dialog box.

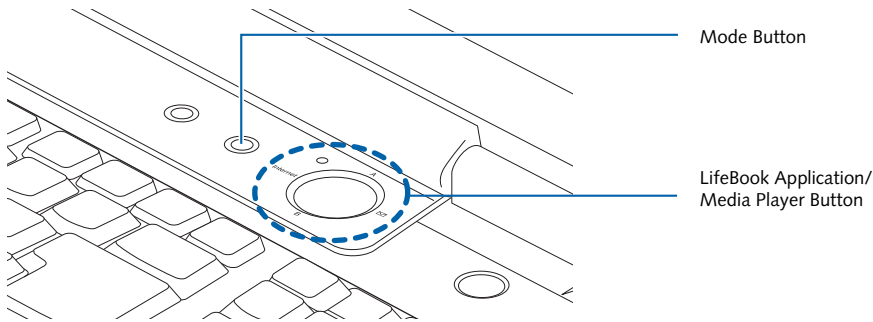

Figure 2-16. LifeBook Application/Media Player Panel Buttons

LifeBook Application/Media Player Panel

A unique feature of your LifeBook notebook is the LifeBook Application/Media Player Panel. This feature makes your LifeBook notebook more than just another notebook computer. The panel allows you to operate the optical drive as an independent audio media player or to launch applications with the touch of one button.



- The LifeBook Application Panel uses the date and time settings of your LifeBook notebook. If the date and time are incorrect, you can adjust the settings in the Windows Control Panel.
- The media player that your LifeBook notebook uses is determined by the configuration of your system.

Your notebook is pre-installed with software utilities that let you operate and configure your LifeBook Application/Media Player Panel. The panel consists of the following elements:

MODE BUTTON

Located at the left of the large LifeBook Application/Media Player button ((Figure 2-16), this button allows you to select the function of the panel—either as an Application Launcher or a media player. When Application Launcher is selected, the mode indicator will light up.(Figure 2-17) When Media Player is selected, the media player indicators will light up. (Figure 2-18).

APPLICATION LAUNCH/MEDIA PLAYER BUTTONS

The LifeBook Application/Media Player Button acts as a one-touch button that allows you to activate a number of functions and actions. If Application Launcher mode is selected, the labels on the outside of the button indicate which area of the button should be pressed to activate the application associated with the label. (Figure 2-17). If Media Player mode is selected, the indicators within the button will light up (Figure 2-18).

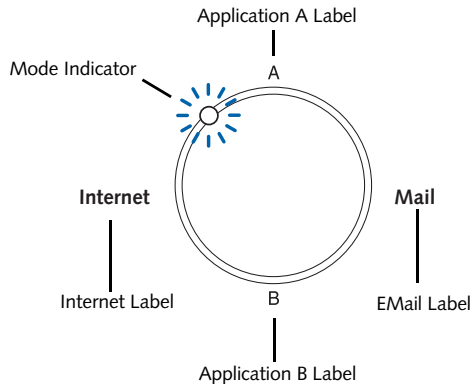

Figure 2-17 LifeBook Application Launch indicators

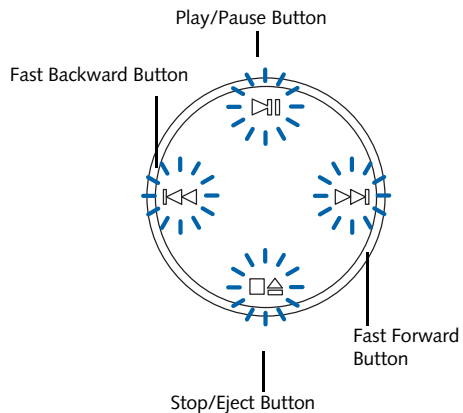

Figure 2-18 Media Player Buttons

CONFIGURING YOUR APPLICATION PANEL

When you start your system, the LifeBook Application Panel is automatically activated. As an application launcher, the LifeBook Application Panel is very flexible, giving you a variety of options. To set up the panel to best suit your needs, we have provided the Application Panel Setup utility that quickly and easily helps you make the most of this valuable feature.

To configure your LifeBook Application Panel:

To configure your LifeBook Application Panel:

1. Open the Control Panel.
2. Double-click on Tablet PC Settings.
3. Select the Buttons tab.
4. Select the button for which you want to modify the default application, then click the [Change] button.
5. Follow the instructions that appear to change the application assigned to the button.

USING THE MEDIA PLAYER BUTTONS

The media player buttons are another way to use your LifeBook notebook's optical drive as a media player.



- If you shut down from Windows while the media player is playing a CD or DVD, it will stop.
- You can't go into Hibernation Mode (Save-to-Disk) or Sleep Mode while the media player is playing.
- The media player will only play when the system is powered on.

There is no configuration required for media player operation. The buttons are pre-configured to work like a normal media player. The buttons will operate as follows:



Stop/Eject

Press this button once to stop a CD or DVD that is playing. Press it twice to eject the disc.

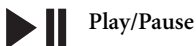

Play/Pause

Press this button to start playing a CD or DVD starting at the beginning. While the disc is playing, press it to pause. Press it again to continue.



- If you press the play button and nothing happens, there is no disc in the media player drive, you have other than a media disc in the drive, or system is not powered on.
- Because of the Windows auto-insertion function, discs will start playing immediately after they are inserted if your LifeBook notebook is on. This will not happen if you are using the media player in Sleep mode.



Fast Backward

Press this button once to skip one track back.

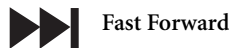

Fast Forward

Press this button once to skip forward one track.

USING THE VISUAL OPTIMIZER

Visual Optimizer is a new feature which allows you to optimize your video viewing experience. The Visual Optimizer image quality enhancer delivers rich image quality by employing cutting-edge technologies such as a 3D color management system, auto contrast correction, black and white stretch, and edge enhancement.

The Visual Optimizer button is located adjacent to the Mode button. (See figure 2-3 on page 8 for location). The Visual Optimizer dynamically and automatically enhances images for optimal quality. To use the Visual Optimizer while viewing videos, press the button to activate it. To de-activate it, press the button again.



3

Getting Started

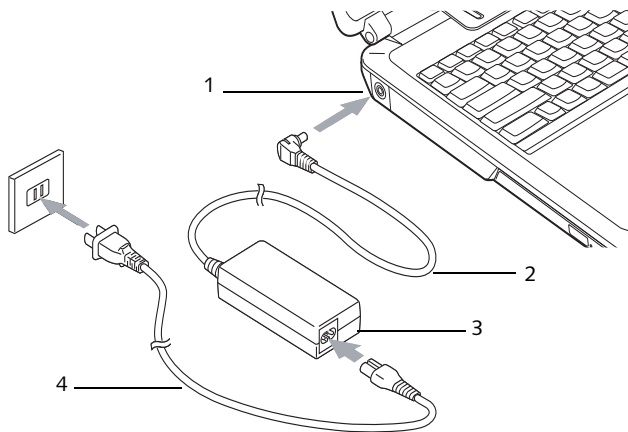

Figure 3-1. Connecting the AC Adapter

1 DC Power Jack
2 DC Output Cable

3 AC Adapter
4 AC Cable

Power Sources

Your Fujitsu LifeBook notebook has two possible power sources: a Lithium ion battery or an AC adapter.

CONNECTING THE AC ADAPTER

The AC adapter provides power for operating your LifeBook notebook and is used to charge the batteries.

Connecting the AC Adapter

1. Plug the DC output cable into the DC power jack of your LifeBook notebook.
2. Plug the AC cable into the AC adapter.
3. Plug the AC cable into an AC electrical outlet.

(Figure 3-1)

Switching from AC Adapter Power to Battery Power

1. Be sure that you have a charged battery installed.
2. Unplug the AC adapter.



- When you run the N6460 LifeBook on battery power, by default, the CPU will slow down approximately by half in order to optimize battery life. This feature can be enabled or disabled in the BIOS. Use an AC Adapter whenever possible.
- The Lithium ion battery is not charged upon purchase. Initially, you will need to connect the AC adapter to use your LifeBook notebook.

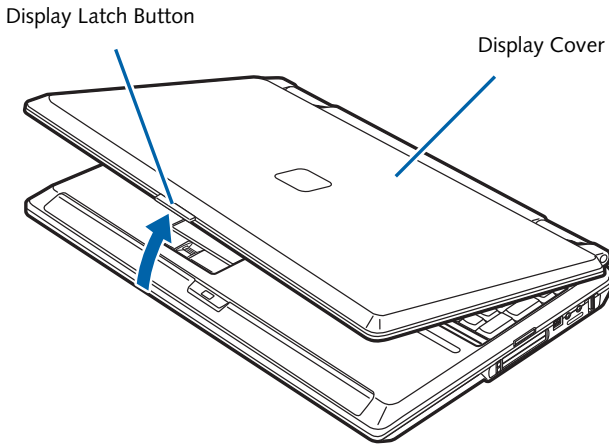

Figure 3-2. Opening the Display Panel

Display Panel

Your Fujitsu LifeBook notebook contains a display panel that is backlit for easier viewing in bright environments and maintains top resolution through the use of active-matrix technology.

OPENING THE DISPLAY PANEL

1. Push the display latch button to release the locking mechanism.
2. Lift the display panel backwards, being careful not to touch the screen, until it is at a comfortable viewing angle.

ADJUSTING DISPLAY PANEL BRIGHTNESS

Once you have turned on your LifeBook notebook, you may want to adjust the brightness level of the screen to a more comfortable viewing level. To adjust the display brightness, use the Function keys on the keyboard.

Using the Keyboard to Change Display Brightness

- [Fn+F6]: Pressing this key combination repeatedly will lower the brightness of your display.
- [Fn+F7]: Pressing this key combination repeatedly will increase the brightness of the display.



- If using AC power, your LifeBook notebook's brightness setting is set to its highest level by default. If using battery power, the brightness setting is set to its middle level by default.
 - The higher the brightness level, the more power the notebook will consume and the faster your batteries will discharge. For maximum battery life, set the brightness level as low as possible.
-
-

CLOSING THE DISPLAY PANEL

1. Holding the edge of your display panel, pull it forward until it is flush with the body of your LifeBook notebook.
2. Push down until you hear a click. This will engage the locking mechanism and prevent your display panel from opening unexpectedly.

Starting Your LifeBook Notebook

POWER ON

Power and Suspend/Resume Button

The Power and Suspend/Resume button is used to power on your LifeBook notebook, to resume from Sleep or Save-to-Disk mode or to place your notebook in Sleep or Save-to-Disk mode. (You can also use the button to power down the system by holding it down for approximately five seconds. This can be useful if the system is “hung up”. This shouldn’t be used as the normal means of shutdown, however.) You can also turn off your notebook by choosing **Shut Down** from the Windows Start menu.

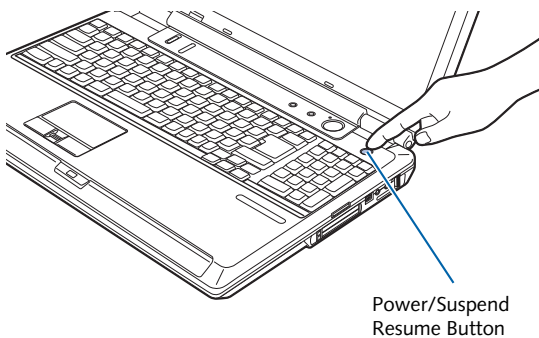

Figure 3-3. Powering Up the System

Once you have connected your AC adapter or charged the internal Lithium ion Battery, you can press this button to power up your notebook. (Figure 3-3)



When you turn on your notebook be sure you have a power source. This means that the battery is installed and charged, or the AC adapter is connected and has power.



Do not carry the notebook around with power on or subject it to vibration or shocks; doing so could damage the notebook.

When you Power On your notebook, it will perform a Power On Self Test (POST) to check the internal parts and configuration for correct functionality. If a fault is found, your notebook will emit an audio warning and/or an error message will be displayed. (See *Power On Self Test Messages on page 61 for more information*).

Depending on the nature of the problem, you may be able to continue by starting the operating system or by entering the BIOS setup utility and revising the settings.

After satisfactory completion of the Power On Self Test (POST), your notebook will load your operating system.



Never turn off your notebook during the Power On Self Test (POST) or it will cause an error message to be displayed when you turn your notebook on the next time. (See *Power On Self Test Messages on page 61 for more information*)

BOOT SEQUENCE

The procedure for starting-up your notebook is termed the Bootup sequence and involves your notebook’s BIOS. When your notebook is first turned on, the main system memory is empty, and it needs to find instructions to start up your notebook. This information is in the BIOS program. Each time you power up or restart your notebook, it goes through a boot sequence which displays a Fujitsu logo until the operating system is loaded. During booting, your notebook is performing a standard boot sequence including a Power On Self Test (POST). When the boot sequence is completed without a failure and without a request for the BIOS Setup Utility, the system displays the operating system’s opening screen.

The boot sequence is executed when:

- You turn on the power to your LifeBook notebook.
- You restart your LifeBook notebook from the Windows Shut Down dialog box.
- The software initiates a system restart. Example: When you install a new application.

HARD DISK DRIVE PASSWORDS

To provide additional security for your data, you can assign passwords to your hard disk drive(s). This feature is managed in the system BIOS Setup Utility. See *BIOS Setup Utility* below for information about accessing the utility.



Remember your passwords. If you set and forget your User and Master hard disk passwords, Fujitsu Computer Systems will not be able to reset it. You may lose data and have to replace your system board or hard disk drive.

BIOS SETUP UTILITY

The BIOS Setup Utility is a program that sets up the operating environment for your notebook. Your BIOS is set at the factory for normal operating conditions, therefore there is no need to set or change the BIOS’ environment to operate your notebook.

The BIOS Setup Utility also allows you to configure such features as the System Data Security feature parameters, such as passwords.

Entering the BIOS Setup Utility

To enter the BIOS Setup Utility do the following:

Using the TrustedCore Menu

When the Fujitsu logo appears on the screen, press the [Enter] key or click on the left mouse or touchpad button; the TrustedCore Menu will appear.

The TrustedCore Menu provides shortcuts to the following menus and information screens:

- BIOS Setup
- Diagnostic Screen
- Boot Menu
- Patent Information
- System Information
- Continue Booting

Click BIOS Setup to open the BIOS Setup Utility.

The Boot Menu can also be invoked by pressing the [F12] key when the Fujitsu logo appears on the screen.

The BIOS Setup Utility can be opened directly by pressing the [F2] key once the Fujitsu logo appears on the screen; this will open the main menu of the BIOS Setup Utility with current settings displayed.

Once the BIOS Setup Utility is open, press the right or left arrow keys to scroll through the other setup menus to review or alter the current settings. Additional navigational information is located at the bottom of the BIOS screen.

BIOS Guide

A guide to your notebook's BIOS is available online at our service and support Website at:

<http://www.computers.us.fujitsu.com/support>.

Once there, select User's Guides under Online Support. Select your Product, Series, and Model, then click [Go].



If your data security settings require it, you may be asked for a password before the BIOS main menu will appear.

BOOTING THE SYSTEM

We strongly recommend that you not attach any external devices and do not put a DVD/CD in your drive until you have gone through the initial power on sequence.

When you turn on your LifeBook notebook for the first time, it will display a Fujitsu logo on the screen. If you do nothing the system will load the operating system, and then the Windows Welcome will begin.

STARTING WINDOWS VISTA THE FIRST TIME

The first time you initialize your Windows Vista system, the screen will be blank for approximately two minutes. This is normal. After initialization, a "Set Up Windows" dialog box will appear.



Important: During the setup procedure, do not disconnect the power supply, press any buttons, or use any peripheral devices such as a mouse, keyboard, or remote control.

In order to ensure that you receive the most benefits from the Windows Vista operating system, it should be registered the first time you use it.

1. First of all, you will need to read and accept the End User License Agreements (EULAs).



- If you reject the terms of the license agreement you will be asked to review the license agreement for information on returning Windows or to shut down your LifeBook notebook.
- You cannot use your notebook until you have accepted the License Agreement. If you stop the process your notebook will return to the beginning of the Windows Welcome Process, even if you shut your notebook down and start it up again.

2. You will be prompted to enter your User Name and Password and you will be given a chance to select an icon for your account.
3. The next screen asks for a Computer Name and allows you to choose a desktop background.
4. You will next see a "Help protect Windows automatically" screen in which the default choice is "Use recommended settings". The other two choices are "Install important updates only" and "Ask me later". Select from the three choices.
5. On the next screen set your time and date settings.
6. You will next see the "Select your computer's current location" screen. Make your selection from Home, Work (Default), and Public location.
7. The "Thank you" screen follows and an offer for free Norton Internet Security is extended. Following are several screens while Windows checks the system performance.
8. Windows will then boot up for the first time.

Registering Windows Vista with Microsoft

1. After Windows has booted up for the first time, the Control Panel Welcome Center will appear. If the Register Windows Online icon is not seen in the window, click on “Show all 14 items”.
2. Click on Register Windows Online and follow the instructions that appear to register your copy of Windows.

REGISTERING YOUR LIFEBOOK NOTEBOOK

How do I register my LifeBook notebook?

You can register your LifeBook by going to our website:

us.fujitsu.com/computers

You will need to be set up with an Internet Service Provider (ISP) to register online.



INSTALLING CLICK ME!



Before installing the ClickMe! utility, be sure the wireless LAN switch is turned on.

The first time you boot up your system, you will see a “Primary Settings for the PC” window. This window explains the installations which will be performed by the Click Me! utility. If you click [Execute], Click Me! will begin installing. If after clicking the button you receive a “User Account Control” window, you will be asked for your permission to continue. Click [Yes] to continue. If you cancel the operation, the Click Me! icon will appear on your desktop for later installation.



There may be additional third-party applications that are not installed by the ClickMe! utility. For more information, refer to your Getting Started Guide.



FUJITSU DRIVER UPDATE UTILITY

Your system has a convenient tool called the Fujitsu Driver Update (FDU) utility. With FDU, you can choose to automatically or manually go to the Fujitsu site to check for new updates for your system. For more information about the FDU utility, refer to “Automatically Downloading Driver Updates” on page 83.

Power Management

Your LifeBook notebook has many options and features for conserving battery power. Some of these features are automatic and need no user intervention, such as those for the internal modem. However, others depend on the parameters you set to best suit your operating conditions, such as those for the display brightness. Internal power management for your LifeBook notebook may be controlled from settings made in your operating system.

Besides the options available for conserving battery power, there are also some things that you can do to prevent your battery from running down as quickly. For example, you can create an appropriate power saving profile, put your notebook into Sleep mode when it is not performing an operation, and you can limit the use of high power devices. As with all mobile, battery powered computers, there is a trade-off between performance and power savings.

POWER AND SUSPEND/RESUME BUTTON

When your LifeBook notebook is active, the Power and Suspend/Resume button can be used to manually put your notebook into Sleep mode. Push the Power and Suspend/Resume button when your notebook is active, but not actively accessing anything, and immediately release the button. You will hear two short beeps and your system will enter Sleep mode.

If your notebook is suspended, pushing the Power and Suspend/Resume button will return your notebook to active operation. You can tell whether or not your system is in Sleep mode by looking at the Power indicator which is part of the Suspend/Resume button. (See *Figure 2-8 on page 15 for location*) If the indicator is visible and not flashing, your LifeBook notebook is fully operational. If the indicator is both visible and flashing, your notebook is in Sleep mode. If the indicator is not visible at all, the power is off or your notebook is in Save-to-Disk (Hibernation) mode. (See *Hibernation (Save-to-Disk) Feature on page 31 for more information*)

SLEEP MODE

Sleep mode saves the contents of your LifeBook notebook's system memory during periods of inactivity by maintaining power to critical parts. This mode will turn off the CPU, the display, the hard drive, and all of the other internal components except those necessary to maintain system memory and allow for restarting. Your LifeBook notebook can be put in Sleep mode by:

- Pressing the Power/Suspend/Resume button when your system is turned on.
- Clicking the power icon on the lock menu.
- Selecting Sleep from the Windows Shut Down menu.

- Timing out from lack of activity.
- Allowing the battery to reach the Dead Battery Warning condition.

Your LifeBook notebook's system memory typically stores the file(s) on which you are working, open application(s) information, and any other data required to support the operation(s) in progress. When you resume operation from Sleep mode, your LifeBook notebook will return to the point where it left off. You must use the Power and Suspend/Resume button to resume operation, and there must be an adequate power source available, or your LifeBook notebook will not resume.

-
-
- If you are running your notebook on battery power, be aware that the battery continues to discharge while your notebook is in Sleep mode, though not as fast as when fully operational.
 - Disabling the Suspend/Resume button prevents it from being used to put your LifeBook notebook in Sleep or Save-to-Disk mode. The resume function of the button cannot be disabled.
 - The Sleep or Hibernation (Save-to-Disk) mode should not be used with certain PC Cards. Check your PC Card documentation for more information.
 - When PC Cards or external devices are in use, Hibernation (Save-to-Disk) mode cannot return to the exact state prior to suspension because all of the peripheral devices will be re-initialized when the system re-starts.
 - If your notebook is actively accessing information when you enter the Sleep or Hibernation (Save-to-Disk) mode, changes to open files are not lost. The files are left open and memory is kept active during Sleep mode, or the memory is transferred to the internal hard drive during Hibernation mode.
 - The main advantage of using the Hibernation (Save-to-Disk) function is that power is not required to maintain your data. This is particularly important if you will be leaving your LifeBook notebook in a suspended state for a prolonged period of time. The drawback of using Hibernation mode is that it lengthens the power down and power up sequences and resets peripheral devices.
 - Your system is set to use the Max Battery power scheme when running on battery power. If you change the power scheme to a different profile, your battery life may vary.



HIBERNATION (SAVE-TO-DISK) FEATURE

The Hibernation feature saves the contents of your notebook's system memory to the hard drive as a part of the Suspend/Resume mode. You can enable or disable this feature.

Enable or Disable the Hibernation Feature

The default settings are not enabled. To enable or disable the Hibernation feature follow these steps:

1. From the **Start** menu, select **Control Panel**, then select **Power Options**.
2. Select "Choose what the power button does" or "Choose what closing the lid does", then make your selections (Do Nothing, Sleep, Hibernate, or Shut Down).

WINDOWS POWER MANAGEMENT

The Power Options icon located in the Windows Control Panel allows you to configure some of the power management settings. For example, you can use the Power Options to set the timeout values for turning off the display and hard disks whether you are running the notebook on battery power or one of the adapters.

RESTARTING THE SYSTEM

If your system is on and you need to restart it, be sure that you use the following procedure.

1. Click the **Start** button, and then move the mouse over the right arrow.
2. Select the desired action from the list.



Turning off your LifeBook notebook without exiting Windows or turning on your notebook within 10 seconds of the notebook being shut off may cause an error when you start the next time.

POWER OFF

Before turning off the power, check that the hard drive/optical drive access indicator is off. If you turn off the power while accessing a disk there is a risk of data loss. To ensure that your notebook shuts down without error, use the Windows shut down procedure.



Be sure to close all files, exit all applications, and shut down your operating system prior to turning off the power. If files are open when you turn the power off, you will lose any changes that have not been saved, and may cause disk errors.

Using the correct procedure to shut down from Windows allows your notebook to complete its operations and turn

off power in the proper sequence to avoid errors. The proper sequence is:

1. Click the **Start** button, and then move the mouse over the right arrow.
2. Select the desired action from the list.

If you are going to store your notebook for a month or more see Care and Maintenance Section.



4

User-Installable Features

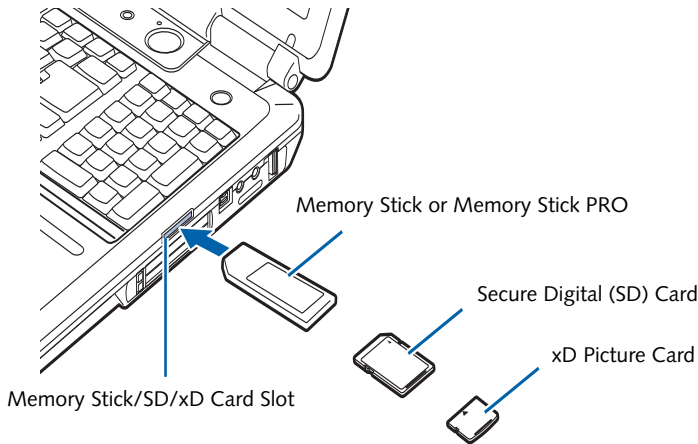

Figure 4-1. Inserting a Memory Stick/SD/xD Card

Memory Stick/Secure Digital/xD Card Slot

Your LifeBook notebook supports the following memory cards, on which you can store and transfer data to and from a variety of digital devices. These cards use flash memory architecture, which means they don't need a power source to retain data.

- SD Memory Card
- Memory Stick Media
- Memory Stick Select Media
- Memory Stick Duo Media (Note: An adapter is required for Memory Stick Duo)
- Memory Stick PRO Media
- xD Picture Cards



- Some of the media in the above list may have more features than others.
- Copyright Protection Technology cannot be used.
- MultiMedia Cards (MMC) and Secure MMC are not supported.

Memory Stick is a flash memory technology developed by Sony Electronics. Memory Stick allows you to record, transfer and share digital content, such as digital pictures, movies, music, voice, and computer data and applications.

Secure Digital (SD) Cards are very similar to Memory Sticks, but they are shorter. Like the Memory Stick, SD Cards allow portable storage among a variety of devices, such as cell phones, GPS systems, digital cameras, and PDAs. SD Cards transfer data quickly, with low battery consumption. Like the memory stick, it uses flash memory architecture.

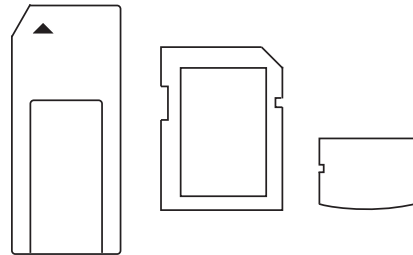

Figure 4-2. Memory Stick, Secure Digital, and xD Cards

INSERTING MEMORY STICK/SD/XD CARDS

Memory Sticks, SD Cards, and xD Cards are inserted in the Memory Stick/SD/xD Card slot (*Figure 4-1*). To insert a Memory Stick, SD Card or xD Card, follow these steps:



- Inserting or removing a Memory Stick, SD Card, or xD Card during your notebook's shutdown or bootup process may damage the card and/or your notebook.
- Do not insert a card into a slot if there is water or any other substance on the card as you may permanently damage the card, your notebook, or both.

1. See your Memory Stick, SD Card, or xD Card manual for instructions on the insertion of your card.
2. Make sure there is no card currently in the slot. If there is, see Removing a Memory Stick/SD/xD Card.
3. Insert the card in an adapter, if required.
4. Insert your card into the slot with the product label facing up.
5. Push the card firmly into the slot until it is seated in the connector.

REMOVING MEMORY STICK/SD/XD CARDS

To remove a Memory Stick, SD Card, or xD Card, follow these easy steps:



- When removing cards from your notebook, be sure to click the Safely Remove Hardware icon in the system tray and select the item you want to remove.
- See your card manual for specific instructions on the removal of your card. Some cards may require your LifeBook notebook to be in Sleep Mode or Off while removing them.

Push the Memory Stick, SD Card, or xD Card adapter in until it unlatches. It will then eject from the slot for removal.

Lithium ion Battery

Your Fujitsu LifeBook notebook has a Lithium ion battery that provides power for operating your notebook when no external power source is available. The rechargeable battery is durable and long lasting, but should not be exposed to extreme temperatures, high voltages, chemicals or other hazards. For information on maximizing your battery life, refer to the section entitled “Power Management” on page 30.

The Lithium ion battery operating time may become shorter if it is used under the following conditions:

- Your system is set to use the Max Battery power scheme when running on battery power. If you change the power scheme to a different profile, your battery life may vary.
- When used at temperatures that exceed a low of 5°C (40°F) or a high of 35°C (95°F). Extreme temperatures not only reduce charging efficiency, but can also cause battery deterioration. The charging icon on the Status Indicator panel will flash when you try to charge a battery that is outside its operating temperature range. (See *Battery Charging Indicator on page 15 for more information*)
- When using a high current device such as a modem, DVD/CD-RW drive, DVD writer, or hard drive, using the AC adapter will conserve your battery life.



- Do not leave a faulty battery in your LifeBook notebook. It may damage your AC adapter or your notebook itself. It may also prevent operation of your notebook by draining all available current into the bad battery.
- Under federal, state, or local law it may be illegal to dispose of batteries by putting them in the trash. Please take care of our environment and dispose of batteries properly. Check with your local government authority for details regarding recycling or disposing of old batteries. If you cannot find this information elsewhere, contact your support representative at: 1-800-8FUJITSU (1-800-838-5487).



Actual battery life will vary based on factors such as screen brightness, applications, features, power management settings, battery condition and other customer preferences. DVD/CD-RW, DVD- writer, or hard drive usage may also have a significant impact on battery life. Battery charging capacity is reduced as the battery ages. If your battery is running low quickly, you should replace it.

RECHARGING THE BATTERIES

If you want to know the condition of the primary Lithium ion battery, check the Battery Status indicator located on the Status Indicator panel. The indicator changes as the battery level changes.

The Lithium ion battery is recharged internally using the AC adapter. To recharge the battery make sure the battery that needs to be charged is installed in your LifeBook notebook and connect the AC adapter.



Make sure the Battery Charging indicator and the percentage charge is shown inside the Battery Status icon on the Status Indicator Panel.

There is no memory effect on the Lithium ion battery therefore you do not need to discharge the battery completely before recharging. The charge times will be significantly longer if your LifeBook notebook is in use while the battery is charging. If you want to charge the battery more quickly, put your LifeBook into Sleep mode, or turn it off while the adapter is charging the battery. (See *Power Management on page 30 for more information on Sleep mode and shutdown procedure*)



Using high current devices such as a modem or frequent optical drive accesses may prevent complete charging.

Low Battery State

When the battery is running low, a low battery notification message will appear. If you do not respond to the low battery message, the batteries will continue to discharge until they are too low to operate. When this happens, your LifeBook notebook will go into Sleep mode. There is no guarantee that your data will not be lost once the notebook reaches this point.

Note that you can change the state in which the battery goes into Sleep mode in the Power properties of the Control Panel.



To prevent loss of data, you should save all your active data and put your notebook into Sleep mode when the low battery message appears, until you can provide a new power source. When you are in Sleep mode, there must always be at least one power source active. If you turn off the power with the power/suspend/resume button, or remove all power sources while your notebook is in Sleep mode, any data that has not been saved to the hard drive will be lost. You should provide power to your notebook from an AC power adapter as soon as possible.

Dead Battery Suspend mode shows on the Status indicator just like the normal Sleep mode. Once your LifeBook notebook goes into Dead Battery Suspend mode you will be unable to resume operation until you provide a source of power from an AC adapter. Once you have provided power, you will need to press the Suspend/Resume button to resume operation. In the Dead Battery Suspend mode, your data can be maintained for some time, but if a power source is not provided promptly, the Power indicator will stop flashing and go out, meaning that you have lost the data that was not stored. Once you provide power, you can continue to use your LifeBook notebook while the adapter is charging the battery.

Shorted Batteries

The Status Indicator panel displays the battery status via the Battery Status indicator to show the charge level available in that battery. If the display is flashing red, it means that the battery is damaged and must be replaced so it does not damage any other parts of your LifeBook notebook.

REPLACING THE BATTERY

With the purchase of an additional battery, you can have a fully charged spare to swap with one that is not charged.

Follow the steps below to replace a battery (*Figure 4-3*):

1. Have a charged battery ready to install.
2. Shut down your notebook and disconnect the AC adapter.
3. Turn the system over.
4. Press the two battery latches towards the battery pack.
5. Lift the battery and remove it from the bay.

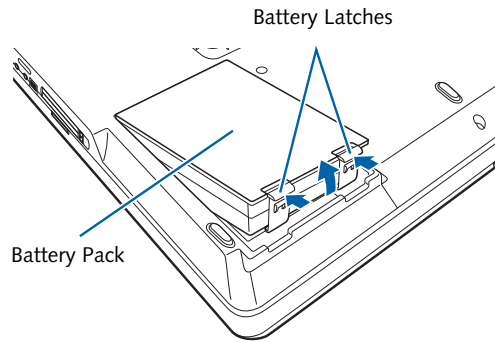

Figure 4-3. Removing the Battery

6. Place a charged battery into the bay and press it down until the latches click into place. (*Figure 4-4*)
7. Plug in the AC adapter and turn the power on.

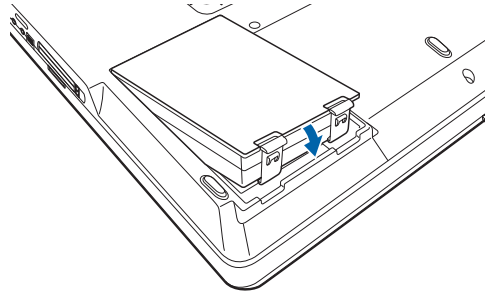

Figure 4-4. Installing the Battery

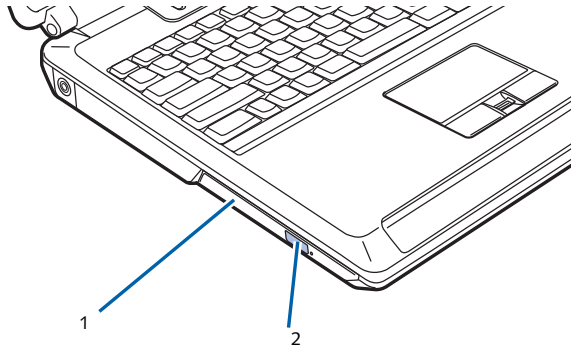

Figure 4-5. Optical Drive

- 1 DVD/CD Holder Tray
- 2 DVD/CD Eject Button

Optical Drive

Your Fujitsu LifeBook notebook contains an optical drive which is either a Dual-Layer Multi-Format DVD Writer or a High-Definition (HD) DVD-ROM player.

OPTICAL DRIVE SOFTWARE

Dual-Layer Multi-Format DVD Writer model only: With this drive, you can play CD-ROM, CD-R, CD-RW, DVD-ROM, DVD-R, DVD-R DL, DVD-RW, DVD+R, DVD+R DL, DVD+RW, DVD-RAM discs, and record CD-R, CD-RW, DVD-R, DVD-R DL, DVD-RW, DVD+R, DVD+R DL, DVD+RW, DVD-RAM discs.

Blu-ray™ model only: With this drive, you can play CD-ROM, CD-R, CD-RW, DVD-ROM, DVD-R, DVD-R DL, DVD-RW, DVD+R, DVD+R DL, DVD+RW, DVD-RAM, BD-ROM, BD-R, BD-R DL, BD-RE, BD-RE DL discs, and record CD-R, CD-RW, DVD-R, DVD-R DL, DVD-RW, DVD+R, DVD+R DL, DVD+RW, DVD-RAM, BD-R, BD-R DL, BD-RE, BD-RE DL discs.



- **Prior to using your Optical Drive, you must install the Optical Player software.** Refer to the applicable readme file on the Driver Applications CD-ROM for instructions on installing your Optical Player software.
- You should periodically check the Fujitsu Website at: us.fujitsu.com/computers for current updated drivers.
- Prolonged use of the optical drive, such as watching a DVD movie, will substantially reduce your battery life.



Do not operate your optical drive unless your LifeBook notebook is sitting on a flat surface. Using a drive when the system is not level may damage the drive or prevent proper operation.

LOADING MEDIA

To load a disc into your optical drive, follow these steps:

1. Push and release the eject button on the front of the optical drive to open the holder tray. The tray will come out of the notebook a short distance.
2. Gently pull the tray out until a media disc can easily be placed in the tray.



There may be a protective sheet in the tray from when it was shipped; please make sure it is removed before operating the drive, otherwise your drive may be damaged.

3. Place the media into the tray, label side up, with the hole in the center of the disc. Snap the disc onto the raised circle in the center of the tray.
4. Gently push the holder tray back in until you hear a click. (Figure 4-6)



If you have disabled the Auto Insert Notification Function, you will have to start the drive from your desktop, since your notebook will not automatically recognize that media has been loaded.

REMOVING MEDIA

1. Push and release the eject button on the front of the optical drive. This will stop the drive and the holder tray will come out of the notebook a short distance.
2. Gently pull the tray out until the disc can easily be removed from the tray.
3. Carefully remove the media disc from the holder tray.
4. Gently push the holder tray back in until you hear a click.

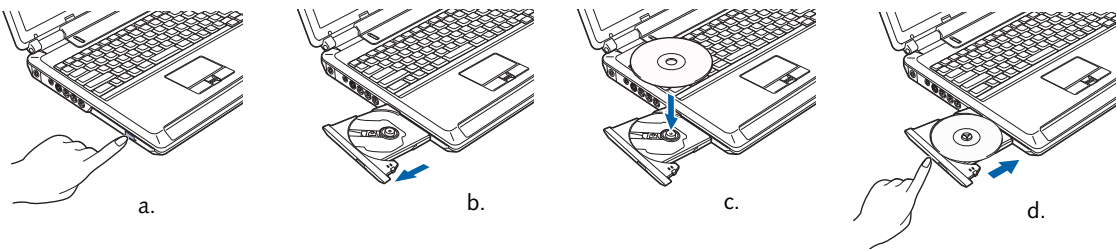

Figure 4-6. Loading Media

EMERGENCY OPTICAL DRIVE TRAY RELEASE

If for some reason the eject button fails, you can open the media tray with a paper clip inserted into the eject hole in the far right side of the front of the tray. Straighten one side of a paper clip and push it gently into the hole. The tray will pop out a short distance.

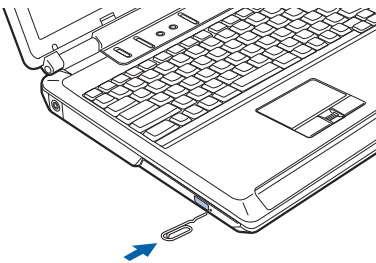

Figure 4-7. Emergency Removal of a CD/DVD

PLAYING MEDIA ON THE OPTICAL DRIVE

There are three ways to operate the optical drive:

- Using the Optical Player Software
- Using the Media Player Buttons
- Using the Desktop Control Panel

USING THE OPTICAL PLAYER SOFTWARE



Prior to using your optical drive, you must install the optical player software. For details on using your optical player software, refer to the software Help file.

Starting a DVD Movie

1. Insert the DVD into the notebook's optical drive. If the CD AutoRun feature activates, skip Step 2.
2. The first time you insert a movie into the DVD/CD-RW tray, you will be prompted to select what you want the system to do when discs are inserted (e.g., start automatically or wait for a prompt). Until you make a selection, you will receive the same prompt whenever you insert a disc.
3. Click OK to close the About DVD Player Performance dialog box and the movie will begin. After you make your selections, the PowerDVD control panel will appear whenever you insert a disc.

Opening the DVD/CD-RW Drive Control Panel

With most DVD-ROMs, you have the option of altering how the movie should play and what you wish to view. You can do this by using the DVD/CD-RW Combo Drive control panel and the mouse.

To open a dropdown menu for options, right-click on the movie screen.

Using the Optical Drive Control Panel

The PowerDVD optical drive software allows you to watch the movie much like a VCR player. You have the option to pause, rewind, fast-forward and stop the movie at any point.

1. To Pause the movie, click the **II** button.
2. To Rewind the movie, click the **◀◀** button to rewind to a specific portion of the movie, or the **◀** button to return to the opening screen.
3. To Fast-forward the movie, click the **▶▶** button to forward to a specific portion of the movie, or the **▶** button to jump to the ending credits.
4. To Stop the movie, click the **■** button.

Exiting the Optical Player

1. Click the **X** in the upper right corner of the title bar.

USING THE DRIVE ON BATTERY POWER

Since optical drives consume a lot of power, your overall battery life will be shorter when operating the optical drive continuously (such as watching a DVD movie). Many movie run-times are longer than your LifeBook notebook can support on a single battery. If you are watching a DVD movie on battery power you may need to swap in an additional, charged battery or attach AC power during the movie to view it in its entirety.



- Prolonged use of the optical drive, such as watching a DVD movie, will substantially reduce your battery life. Many movie run-times are longer than your system can support on a single battery. If you are watching a DVD movie on battery power you may need to swap in an additional, charged battery or attach AC power during the movie to view it in its entirety.
- An additional battery is recommended if you will be watching DVD movies on battery power. If you don't have an additional battery, you may purchase one either on-line at: www.shopfujitsu.com or call 1-877-372-3473.

To Watch a Movie on Battery Power:

1. Have an additional fully-charged battery or your AC adapter ready for use.
2. Start watching your DVD movie.
3. When the low battery warning occurs, immediately stop the movie and exit the optical player.



If you don't stop the optical drive quickly and the notebook attempts to auto-suspend (critical battery low state) the notebook will shut down improperly. If this occurs, you will need to power the system up with the power/suspend/resume button and follow any instructions that appear.

4. Manually place your notebook into Sleep mode by depressing the Suspend button. Plug in a power adapter and replace the discharged battery with an additional fully-charged battery. If you do not have an additional battery, you may use the AC power adapter as your power source to continue watching the movie while recharging the installed battery.
5. Resume your notebook by pressing the Suspend button again. This step is not required if you attached AC power without entering Sleep mode.
6. Restart your optical drive, locate and skip to the chapter of the movie you were last watching.
7. Continue watching your DVD movie.



Some shorter DVD movies may not require you to swap batteries or attach AC power to complete them. However, it is best to be prepared since actual battery life while operating the optical drive cannot be guaranteed.

AUTO INSERT NOTIFICATION FUNCTION

The Auto Insert Notification function allows your Life-Book notebook to automatically start a DVD/CD as soon as it is inserted in the optical drive and the tray is closed. Your notebook will begin playing an audio DVD/CD or will start an application if the DVD/CD includes an auto run file.

To prevent a CD from playing automatically as soon as it is inserted, refer to the related help file for your specific operating system.

Hard Disk Drive

Your Fujitsu LifeBook notebook hard disk drive capacity is dependent on which model you are using. Some LifeBook notebooks may also contain a second hard disk drive in addition to the primary hard disk drive. (See *Specifications on page 73 for more information*)

FORMATTING THE HARD DISK DRIVE

The internal hard disk drive is formatted, or initialized, at the factory. You do not need to format it under normal circumstances. If you decide to reformat due to corruption or upgrade, please refer to your operating system documentation for the correct procedure.



You should not reformat your hard disk unless you are instructed to do so by Technical Support. Reformatting the hard disk drive will erase all of the data currently stored on it, including the operating system and installed programs.

Before you reformat your hard disk drive, please note:

- Any data that currently resides on your hard disk drive must be backed-up to floppy disks or other data storage media, or it will be permanently lost. These back-up disks can then be used to reinstall and restore your data. (See *your operating system manual for more information on backing-up your data files*)
- All application software that is installed on the hard disk drive, must be reinstalled from the original source.

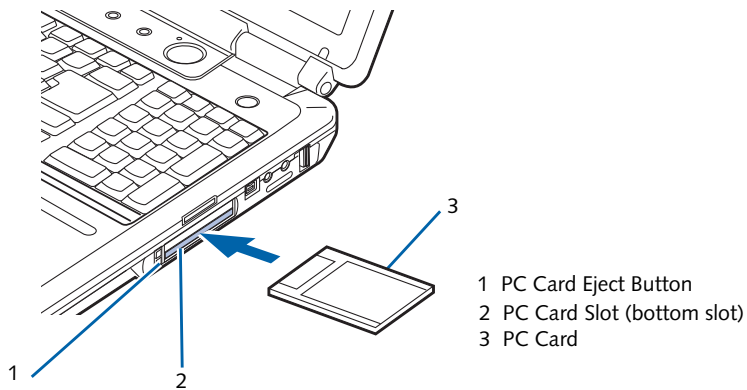

Figure 4-8. Installing/Removing PC Cards

PC Cards/ExpressCards™

Your LifeBook notebook supports Type I and Type II PC Cards and ExpressCards™, in separate dedicated slots. With these cards you can perform a variety of functions depending on which type of card you install. You can install one or two cards at a time, depending on its type. PC Cards should be installed in the bottom slot and ExpressCards in the top slot. (Figure 4-8)

Some available PC/ExpressCards:

- Wireless LAN PC Cards (Type II)
- ExpressCard Hybrid TV Tuner
- Local area network (LAN) cards (Type II)
- IDE solid-state disk cards (Type II)
- SCSI cards (Type II)
- PC Cards that conform to PCMCIA 2.1 or CardBus

For further information, refer to the instructions supplied with your card(s).

INSTALLING PC CARDS

PC Cards are installed in the PC Card slot (Figure 4-8). To install a PC Card, follow these steps:

1. See your PC Card manual for instructions on the installation of your card. Some cards may require that your notebook is off while installing them.
2. Make sure there is no PC Card currently in the slot. If there is, see Removing PC Cards.
3. If the eject button is extended, press it until it clicks.
4. Insert the card into the slot with the label facing up.
5. Push the card firmly into the slot until it is seated in the connector.

REMOVING PC CARDS

See your PC Card manual for specific instructions on removing your card. Some cards may require your notebook to be in Sleep Mode or Off during removal.



- Windows has a shutdown procedure for PC Cards that must be followed before removing a card. (Review your operating system manual for the correct procedure.) It is good practice to remove devices using the Safely Remove Hardware icon in the system tray.
- If the dialog box states that the device cannot be removed, you must save all of your open files, close any open applications and shut down your notebook.



You may be required to log on as an Administrator or member of the Administrator's Group to complete this procedure. If the computer is connected to a network, network policy settings may also prevent you from completing this procedure.



- Installing or removing a PC Card during your LifeBook notebook's shutdown or bootup process may damage the card and/or your LifeBook notebook.
- Do not insert a PC Card into a slot if there is water or any other substance on the card as you may permanently damage the card, the notebook, or both.



If the PC Card has an external connector and cable, do not pull the cable when removing the card.

INSTALLING EXPRESSCARDS

There are two different width ExpressCards: 34 mm and 54 mm ("ExpressCard 34" and "ExpressCard 54"). (Figure 4-9). The connector inside the slot is located on the left-hand side of the slot. If you insert a 34 mm card, be sure to align it with the left side of the slot when inserting it.

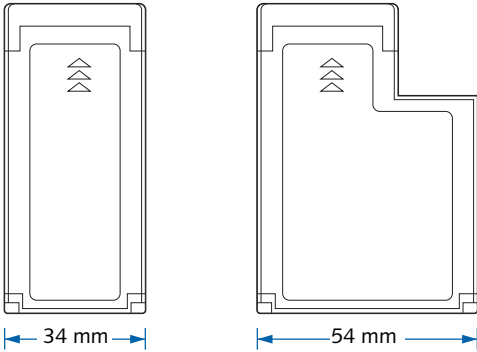
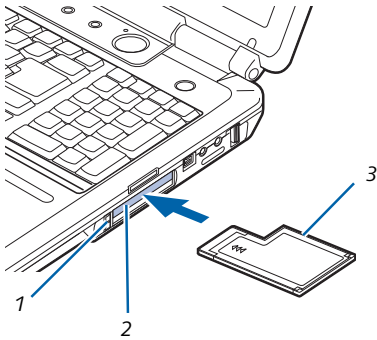

Figure 4-9 ExpressCard Sizes

ExpressCards are installed in the ExpressCard slot (the top slot). (Figure 4-10).



- 1 ExpressCard Eject Button
- 2 ExpressCard Slot
- 3 ExpressCard

(An ExpressCard 54 is used in the illustration.)

Figure 4-10. Installing/Removing ExpressCards



- Installing or removing an ExpressCard during your notebook's shutdown or bootup process may damage the card and/or your notebook.
- Do not insert an ExpressCard into a slot if there is water or any other substance on the card as you may permanently damage the card, your notebook, or both.



- When you receive your system, there may be a plastic slot protector installed in the ExpressCard slot. Before installing an ExpressCard, remove the slot protector in accordance with the "Removing ExpressCards" section. When you do not have a card installed in the slot, be sure to re-install the slot protector to prevent the system from being contaminated.

- You may be required to log on as Administrator or a member of the Administrator's Group to complete this procedure. If your computer is connected to a network, network policy settings may also prevent you from completing this procedure.

See your ExpressCard manual for instructions on the installation of your card. Some cards may require that your notebook is off while installing them.

To install an ExpressCard, follow these steps:

1. Make sure there is no ExpressCard currently in the slot. If there is, see Removing ExpressCards.
2. Insert your ExpressCard into the slot with the product label facing up. If you are inserting a 34 mm card, be sure to align it with the left side of the slot when inserting it.
3. Push the card firmly into the slot until it is seated in the connector.

REMOVING EXPRESSCARDS

See your ExpressCard manual for specific instructions on removing your card; some cards may require your notebook to be in Sleep Mode or Off during removal.



- Windows has a shutdown procedure for ExpressCards that must be followed before removing a card. (Review your operating system manual for the correct procedure.) It is good practice to remove devices using the Safely Remove Hardware icon in the system tray.
- If the dialog box states that the device cannot be removed, you must save all of your open files, close any open applications and shut down your notebook.

To remove an ExpressCard, press the card into the slot. This will cause the card to be ejected slightly out of the slot allowing you to remove the card.

Memory Upgrade Module

Your notebook has two memory slots, and the system comes with 1 GB, 2 GB, or 4 GB of factory-installed memory. If you have a module installed in only one slot, you can increase your memory capacity by installing another memory module in the empty slot or by increasing the size of the single installed module. The minimum amount of memory in your system is 1GB.



- Systems with Microsoft Windows Vista installed require a minimum of 512 MB of memory, but 1 GB or more is recommended.
- If 4 GB of memory is installed in your system, only 3.25 GB are usable, due to operating system constraints.

Your notebook supports dual-channel memory, which can have a significant effect upon your system's performance. In order to support dual-channel memory, two DIMM modules must be installed in your computer.

- Do not remove any screws from the memory upgrade module compartment except the ones specifically shown in the directions for installing and removing the memory upgrade module.
- The memory upgrade module can be severely damaged by electrostatic discharge (ESD). To minimize risk to the module, observe the following:
 - Before handling a memory module, touch a grounded metal object to discharge static electricity built up in your body.
 - When installing or removing a memory module, hold it by the edge so as not to touch any contacts or chips. Do not touch any internal computer terminals or components; the oil from your fingers could cause a short to the components.
 - Power down your system before you add or remove memory modules. Even if the system is in hibernate or Sleep states, data could be lost or the memory could be damaged if power is still available to the system.



The installation of incompatible memory modules can cause numerous problems which could result in loss of data. Memory upgrades must be PC2-5300 DDR2-667 SO-DIMM modules. Fujitsu **highly recommends** that you only purchase additional memory from the Fujitsu on-line accessory store at: us.fujitsu.com/computers.

INSTALLING A MEMORY MODULE

1. Turn off power to your LifeBook notebook using the power/suspend/resume button, and remove any power adapter.
2. Make sure that all the connector covers are closed.
3. Turn the LifeBook notebook bottom side up, with the front panel toward you.
4. Remove the screws at the front of the memory upgrade module compartment. (*Figure 4-11*)
5. Remove the cover by tilting the front edge up, then pulling forward until the tabs on the cover are free.

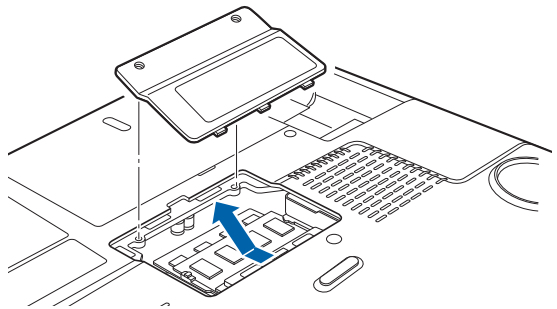

Figure 4-11. Opening the Memory Upgrade Compartment

6. Remove the memory upgrade module from the static guarded sleeve.
7. Align the memory upgrade module with the part side up. Align the connector edge of the memory upgrade module with the connector slot in the compartment. The connector will be pointing toward the rear of the LifeBook notebook.
8. Insert the memory upgrade module at a 45° angle. Press the connector edge of the module firmly down and into the connector until it lodges under the retaining clip. You will hear a click when it is properly in place. (*Figure 4-12*)

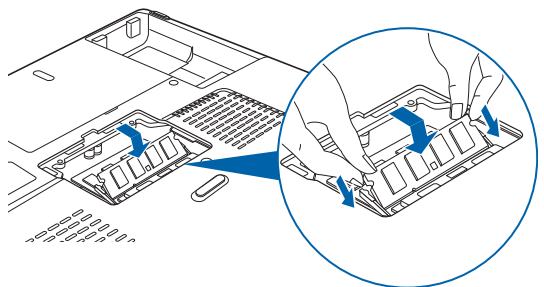

Figure 4-12. Installing a Memory Upgrade Module

9. Replace the cover by hooking the tabs under the rear edge of the compartment opening and tilting down until flush with the bottom of your notebook.
10. Replace the screws.



The memory upgrade module is not something you should routinely remove from your notebook. Once it is installed, you should leave it in place unless you want to increase system memory capacity.

REMOVING A MEMORY UPGRADE MODULE

1. Perform steps 1 through 5 of Installing a Memory Upgrade Module.
2. Pull the clips sideways away from each side of the memory upgrade module at the same time.
3. While holding the clips out, remove the module from the slot by lifting it up and pulling towards the rear of your LifeBook notebook. (Figure 4-13)

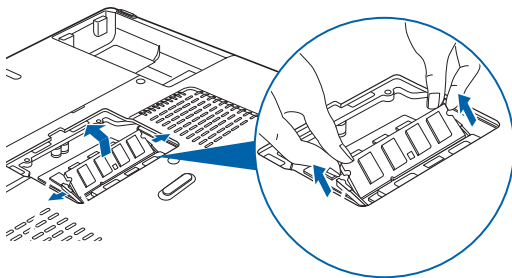

Figure 4-13. Removing a Memory Upgrade Module

4. Store the memory upgrade module in a static guarded sleeve.
5. Replace the cover by following steps 9 and 10 of Installing a Memory Upgrade Module.



After installing your added memory module, you must complete the Resetting the Save-to-Disk Parameters procedure in order for the Save-to-Disk mode to operate properly on your LifeBook notebook. (See *Hibernation (Save-to-Disk) Feature* on page 31 for more information)

CHECKING THE MEMORY CAPACITY

Once you have changed the system memory capacity by replacing the installed module with a larger one, be sure to check that your notebook has recognized the change.

Check the memory capacity by clicking [Start] -> Control Panel -> System and Maintenance -> System. The amount of memory is displayed next to "Memory - RAM:"

The amount of memory displayed should be approximately the total of all memory modules installed. There may be a discrepancy which is allocated for fixed video memory.



If the total memory displayed is incorrect, check that your memory upgrade module is properly installed. (If the module is still not correctly recognized, see *Troubleshooting* on page 53.

ENABLING/DISABLING TURBO MEMORY

Turbo Memory is an optional module that is used to act as a cache for frequently-accessed applications and information. If you have Turbo Memory installed in your system, it can be enabled or disabled as follows:



NVCache Partition: Please note that the NVCache partition on your hard disk drive is dedicated to the Turbo Memory module. If you see the NVCache partition, DO NOT copy any data to it or use this partition directly. Doing so could result in data loss or corruption, for which Fujitsu is not responsible.

Enabling Windows ReadyBoost™

To enable Windows ReadyBoost for Intel® Turbo Memory, perform the following simple steps:

1. Click on Start -> All Programs.
2. Locate the Intel Turbo Memory program group.
3. Select Intel Turbo Memory Console.
4. Select [Continue] when you see the Microsoft® Windows User Account Control prompt that says "A program needs your permission to continue. If you started this program, continue."
5. Select [Enable Windows ReadyBoost].
6. Reboot your system.

Device Ports

Your LifeBook notebook comes equipped with multiple ports to which you can connect an external device including: disk drives, keyboards, modems, printers, etc.

COMMUNICATIONS PORTS

Your LifeBook has a Modem jack (RJ-11) and a LAN jack (RJ-45) to accommodate external communications.

Modem (RJ-11) Telephone Jack

The modem (RJ-11) telephone jack is used for your internal modem. To connect the telephone cable follow these easy steps: (Figure 4-14)

1. Align the connector with the port opening.
2. Push the connector into the port until it is seated.
3. Plug the other end of the telephone cable into a telephone outlet.

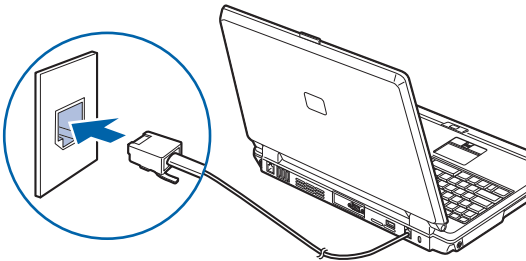

Figure 4-14. Connecting the Modem



Do not connect the internal modem to a Digital PBX as it may cause serious damage to the modem or your LifeBook notebook. It should be noted that some hotels use the Digital PBX systems, please be sure to find out BEFORE you connect your modem. Consult your PBX manufacturer's documentation for more information.



The internal modem is designed to the ITU-T V.90 standard. Its maximum speed of 53000bps is the highest allowed by the FCC, and its actual connection rate depends on the line conditions. The maximum speed is 33600bps at upload.

The modem sound is deactivated by default, to activate modem sound follow these easy steps:

1. Select [Start] -> Control Panel.
2. Select Classic View in the left pane.
3. Double-click Phone and Modems.
4. You may initially need to enter your area code in order to open the Phone and Modem Options window.

5. Select the Modems tab, and click the [Properties] button.
6. Select the Modem tab and adjust the volume as necessary

LAN PORT

This port allows you to connect a LAN (RJ-45) cable for high-speed network or broadband connections (e.g., DSL, cable modem). (Figure 4-15)

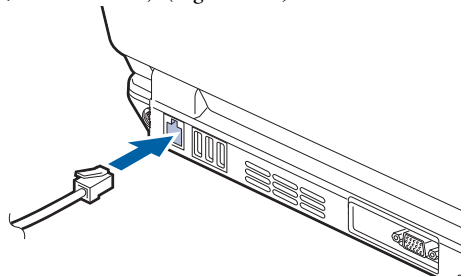

Figure 4-15. Connecting the LAN

IEEE 1394 JACK

The 4-pin IEEE 1394 (Firewire) jack is a high-speed interface (400 Mbps) that can be used to transfer large amounts of data between your notebook and a Firewire peripheral such as a digital camera, external hard drive, or video camera. Hot-swappable and plug-n-play, it is much faster than USB 1.1, CardBus, or parallel port. To connect a 1394 device, follow these steps: (Figure 4-16)

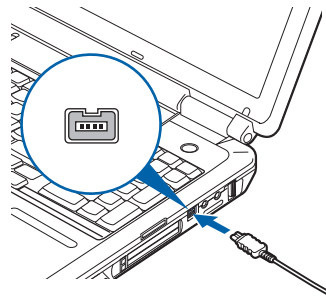

Figure 4-16. IEEE 1394 Interface



The 1394 port in this system uses a four-pin configuration. If you intend to interface with devices which have a six-pin configuration, you will need to purchase an adapter.

HDMI PORT

The High-Definition Multimedia Interface (HDMI) port is a digital audio/video interface over which uncompressed streams can be transmitted. This port is used to connect compatible digital devices with your computer (such as large-screen HDTVs and high-end digital cameras and video recorders).

To connect an HDMI device, follow these steps: (Figure 4-17)

1. Align the connector with the port opening.
2. Push the connector into the port until it is seated.

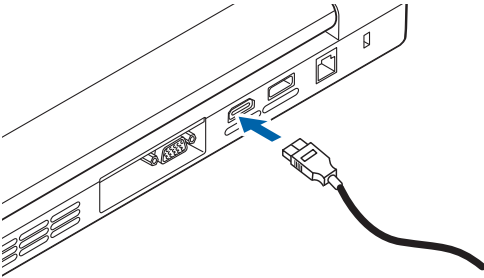

Figure 4-17. HDMI Interface

UNIVERSAL SERIAL BUS (USB) 2.0 PORTS

The five Universal Serial Bus (USB) 2.0 ports allow you to connect USB devices such as game pads, pointing devices, keyboards and speakers. There is one USB 2.0 port on the right side, and four on the rear panel. (Figure 4-18).



Note that only the **individual horizontal USB port on the right rear** of the system can be used to connect an infrared remote control receiver that is required when using the optional Media Center Edition remote control.

USB 2.0 is downward-compatible with USB 1.1 devices, so older USB devices will work with these ports. USB 2.0 is a much faster design, running forty times faster than USB 1.1. To connect a USB device follow these steps:

1. Align the connector with the port opening.
2. Push the connector into the port until it is seated.

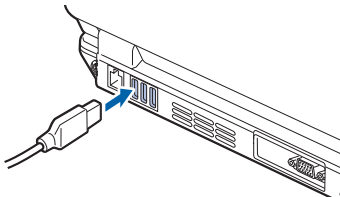

Figure 4-18. Connecting a USB Device

S-VIDEO OUT PORT

The S-Video port allows you to connect and use directly any S-Video device, such as a VCR or television. The S-Video standard provides for a higher quality picture than Composite. In order to connect an S-Video device, follow these easy steps: (Figure 4-19)

1. Align the connector with the port opening.
2. Push the connector into the port until it is seated.

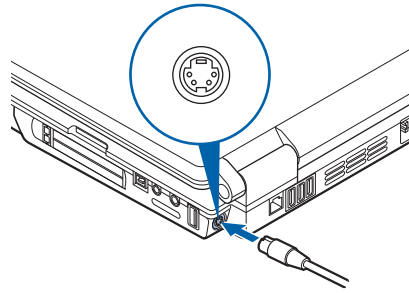

Figure 4-19. S-Video Jack

MICROPHONE JACK

The microphone jack allows you to connect an external stereo microphone. Your microphone must be equipped with a 1/8" (3.5 mm) mono mini-plug in order to fit into the microphone jack of your LifeBook notebook. In order to connect a microphone follow these easy steps:

1. Align the connector with the port opening.
2. Push the connector into the port until it is seated.

HEADPHONE/SPDIF JACK

The headphone jack allows you to connect headphones or powered external speakers to your LifeBook notebook. Your headphones or speakers must be equipped with a 1/8" (3.5 mm) stereo mini-plug.

The SPDIF function of the jack allows you to download digital audio to MiniDisc recorders. It uses SPDIF (Sony Philips Digital Interface) format. Use the following setting when using the digital audio-out connector.

To connect headphones or speakers, follow these steps:

1. Align the connector with the port opening.
2. Push the connector into the port until it is seated.

- There are several types of cables for connecting a digital electronic device to the digital audio-out connector, depending on the connector type. The connector on your computer is a Optical Mini Plug (3.5mm diameter mini plug)

- The frequency of digital sound output from the SPDIF output connector is selectable as 48.0 kHz or 44.1 kHz. If a sampling rate converter is not installed in your digital electronic device (e.g., MD player), recording is not possible. See the device user manual for more details.



- The sound recorded through connecting a digital electronic device (e.g., MD player) to the SPDIF output connector cannot be used as digital output. All output data from the SPDIF output connector has copyright protection information included.



If you plug headphones into the headphone jack, you will disable the built-in stereo speakers.

EXTERNAL VIDEO PORT

The external video port allows you to connect an external monitor or LCD projector. In order to connect an external device follow these easy steps:

1. Align the connector with the port opening.
 2. Push the connector into the port until it is seated.
 3. Tighten the two hold-down screws, located on each end of the connector.
-
-



Pressing the [Fn] + [F10] keys allows you to change your selection of where to send your display video. Each time you press the key combination, you will step to the next choice, starting with the built-in display panel only, moving to the external device only, finally moving to both the built-in display panel and an external video device.

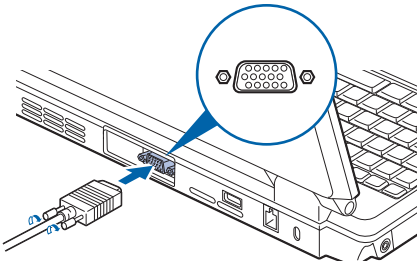

Figure 4-20. External Video Connection



5

Troubleshooting

Troubleshooting

Your LifeBook notebook is sturdy and subject to few problems in the field. However, you may encounter simple setup or operating problems that you can solve on the spot, or problems with peripheral devices, that you can solve by replacing the device. The information in this section helps you isolate and resolve some of these straightforward problems and identify failures that require service.

IDENTIFYING THE PROBLEM

If you encounter a problem, go through the following procedure before pursuing further troubleshooting:

1. Turn off your LifeBook notebook.
2. Make sure the AC adapter is plugged into your LifeBook notebook and to an active AC power source.
3. Make sure that any card installed in the PC Card slot is seated properly. You can also remove the card from the slot, thus eliminating it as a possible cause of failure.
4. Make sure that any devices connected to the external connectors are plugged in properly. You can also disconnect such devices, thus eliminating them as possible causes of failure.
5. Turn on your LifeBook notebook. Make sure it has been off at least 10 seconds before you turn it on.
6. Go through the boot sequence.
7. If the problem has not been resolved, refer to the Troubleshooting Table, that follows, for more detailed troubleshooting information.



If you keep notes about what you have tried, your support representative may be able to help you more quickly by giving additional suggestions over the phone.

8. If you have tried the solutions suggested in the Troubleshooting Table without success, contact your support representative:
 - Toll free: 1-800-8Fujitsu (1-800-838-5487)
 - E-mail: 8fujitsu@us.fujitsu.com/computers
 - Website: <http://www.computers.us.fujitsu.com/support>

Before you place the call, you should have the following information ready so that the customer support representative can provide you with the fastest possible solution:

- Product name
- Product configuration number
- Product serial number
- Purchase date
- Conditions under which the problem occurred
- Any error messages that have occurred
- Type of device connected, if any

See the Configuration Label on the bottom of your LifeBook notebook for configuration and serial numbers.



Do not return a failed LifeBook notebook to Fujitsu until you have received a Return Material Authorization (RMA) number from a support representative.

SPECIFIC PROBLEMS

Using the Troubleshooting Table

When you have problems with your LifeBook notebook, try to find the symptoms under the Problem column of the troubleshooting table for the feature giving you difficulty.

TROUBLESHOOTING TABLE

You will find a description of common causes for that symptom under the column Possible Cause and what, if anything, you can do to correct the condition under Possible Solutions. All possible causes or solutions may not apply to your LifeBook notebook.

Problem	Page
Audio Problems	page 54
DVD/CD-ROM Drive Problems	page 54
Hard Drive Problems	page 55
Keyboard or Mouse Problems	page 55
Memory Problems	page 56
Modem Problems	page 56
USB Device Problems	page 56
PC Card Problems	page 56
Power Failures	page 57
Shutdown and Start-up Problems	page 58
Video Problems	page 59

Problem	Possible Cause	Possible Solutions
Audio Problems		
There is no sound coming from the built-in speakers.	The volume is turned too low.	Adjust the volume control on your notebook.
	The software volume control is set too low.	Adjust the sound volume control settings in your software, operating system and applications.
	Headphones are plugged into your notebook.	Plugging in headphones disables the built-in speakers, remove the headphones.
	BIOS audio settings are incorrect.	Set the BIOS setup utility to the default values within the Multimedia Device Configuration menu. (See <i>BIOS Setup Utility page 27 for more information</i>)
	Software driver is not configured correctly.	Refer to your application and operating system documentation for help.
	Sound may be set to Mute.	Click on the Volume icon in the notification area and verify that the Mute checkbox is not set.
	Device Manager may not be set correctly.	Go to the Control Panel -> System, and click on the Hardware tab. Click [Device Manager] and scroll down to verify that all devices are set properly.
DVD/CD-ROM Drive Problems		
Notebook fails to recognize DVD/CDs.	DVD/CD is not pushed down onto center circle of the drive.	Open the DVD/CD-ROM tray and re-install the disk properly.
	DVD/CD-ROM tray is not latched shut.	Push on the front of the DVD/CD-ROM tray until it latches.
	Wrong drive designator was used for DVD/CD in the application.	Verify that the drive designator used by the application is the same as that used by the operating system. When the operating system is booted from a DVD/CD, drive designations are automatically adjusted.
	Windows DVD/CD Auto Insert Notification function is disabled.	Start the DVD/CD from the desktop or application software or re-enable the Windows DVD/CD Auto Insert Notification function. (See <i>Auto Insert Notification Function page 41 for more information</i>)
	DVD/CD is dirty or defective.	Wipe DVD/CD with a non-abrasive CD cleaning cloth and reinsert. If it still will not work try another DVD/CD in the drive.

Problem	Possible Cause	Possible Solutions
LifeBook notebook fails to auto-play DVD movie.	DVD Player Software is not installed.	Install DVD Player Software using the DVD Application.
	Country designator could be set incorrectly.	Select the DVD player software from the programs list and right-click on the window. Select Properties and verify that the region selected is "USA, Canada."
The DVD/CD-ROM Access indicator on the Status Indicator Panel blinks at regular intervals when no disk is in the tray or the DVD drive is not installed.	The Windows DVD/CD Auto Insert Notification function is active and is checking to see if a DVD/CD is ready to run.	This is normal. However, you may disable this feature. (<i>See Auto Insert Notification Function page 41 for more information</i>)
Hard Drive Problems		
You cannot access your hard drive.	The setup utility is incorrectly set for your internal hard drive.	Set Primary Master correctly in the BIOS. (<i>See BIOS Setup Utility page 27 for more information</i>)
	The wrong drive designator was used by an application when a bootable CD-ROM was used to start the notebook.	Verify drive designator used by application is in use by the operating system. When the operating system is booted from a CD, drive designations are automatically adjusted.
	Security is set so your operating system cannot be started without a password.	Verify your password and security settings.
	The hard disk drive has crashed.	Contact Fujitsu or your local authorized reseller for a replacement hard disk drive.
Keyboard or Mouse Problems		
The built-in keyboard does not seem to work.	Your application has locked out your keyboard.	Try to use your integrated pointing device to restart your system. If this fails, turn your notebook off using the power/suspend/resume button, wait 10 seconds or more, and then turn it back on.
	The NumLk key is set.	Press the NumLk key to reset it.
You have installed an external keyboard or mouse, and it doesn't work.	Your external device is not properly installed.	Reinstall your device. (<i>See Device Ports page 47 for more information</i>)
	Your operating system is not set up with the correct driver for that device.	Check your device and operating system documentation and activate the proper driver.
You have connected an external keyboard or a mouse and it seems to be locking up the system.	Your operating system software is not set up with the correct driver for that device.	Check your device and operating system documentation and activate the proper driver.
	Your system has crashed.	Try to restart your LifeBook notebook. If that fails, turn off the power using the power/suspend/resume button, wait at least 10 seconds, and then power on. If turning off power with the power/suspend/resume button fails, the button has likely been set to suspend or hibernate. In that case, disconnect the power cord, then remove and re-insert the battery.

Problem	Possible Cause	Possible Solutions
Memory Problems		
Your Main menu of the BIOS setup utility information, does not show the correct amount of installed memory.	Your memory upgrade module is not properly installed.	Remove and reinstall your memory upgrade module. (See <i>Memory Upgrade Module</i> page 45 for more information)
	You have a memory failure.	Check for POST messages. (See <i>Power On Self Test Messages</i> page 61 for more information)
Modem Problems		
Messages about modem operation.	Messages about operation are generated by whichever modem application is in use.	See your application software documentation for additional information.
USB Device Problems		
You have installed a USB device, but your LifeBook notebook does not recognize the device, or the device does not seem to work properly.	The USB device is not properly installed and/or powered.	Verify the USB is properly installed by unplugging and replugging the plug. Also, verify that sufficient power is available to the USB device.
	The USB port is not enabled in the BIOS.	Verify the USB port is Enabled in the BIOS. (See <i>Entering the BIOS Setup Utility</i> page 27 for more information)
	The device is not properly installed.	Remove and reinstall the device. (See <i>Device Ports</i> page 47 for more information)
	The device may have been installed while an application was running, so your notebook is not aware of its installation.	Close the application and restart your LifeBook notebook.
	Your software may not have correct software driver active.	See your software documentation and activate the correct driver.
	You may have the wrong I/O address selected for your device.	See your device documentation and software documentation to determine the required I/O address. Change the settings in the Device Manager.
	Your device and another device are assigned the same I/O address.	Check all I/O addresses located within the Device Manager and any other installed hardware or software to make sure there are no duplications.
PC Card Problems		
A card inserted in the PC Card slot does not work or is locking up the system.	The card is not properly installed.	Remove and reinstall the card. (See <i>Removing PC Cards</i> page 43 for more information)
	Your software may not have the correct driver active.	See your software documentation and activate the correct driver.
	The card may have been installed while an application was running, so your notebook is not aware of its installation.	Close the application and restart your LifeBook notebook.
	You may have the wrong I/O address selected for your PC Card device.	See your PC Card documentation to determine the required I/O address. Change the settings in the Device Manager.

Problem	Possible Cause	Possible Solutions
A card inserted in the PC Card slot does not work or is locking up the system. (continued)	Your PC Card device and another device are assigned the same I/O address.	Check all I/O addresses located within the Device Manager and any other installed hardware or software to make sure there are no duplications.
Power Failures		
You turn on your LifeBook notebook and nothing seems to happen.	The installed primary battery is discharged, there's no second battery installed or there is no AC adapter installed.	Check the Status Indicator Panel to determine the presence and condition of the batteries. (<i>See Status Indicator Panel page 15 for more information</i>) Install a charged battery or a Power adapter.
	The battery is installed but is faulty.	Use the Status Indicator panel to verify the presence and condition of the batteries. (<i>See Status Indicator Panel page 15 for more information</i>) If a battery is indicating a short, remove that battery and operate from another power source or replace that battery.
	The battery or batteries are low.	Check the Status Indicator Panel to determine the presence and condition of the batteries. (<i>See Status Indicator Panel page 15 for more information</i>) Use a Power adapter to operate until a battery is charged or install a charged battery.
	The AC adapter is not plugged in properly.	Verify that your adapter is connected correctly. (<i>See Power Sources page 25 for more information</i>)
	The Power adapter has no power from the AC outlet.	Move the AC cord to different outlet, check for a line switch or tripped circuit breaker for the AC outlet.
	The AC adapter is faulty.	Try a different Power adapter.
Your LifeBook notebook turns off all by itself.	The power management parameters are set for auto timeouts which are too short for your operating needs.	Press any button or key on the keyboard, or move the mouse. If that fails, push the Power/Suspend/Resume button. Check your power management settings, or close your applications and go to the Power Savings menu of the setup utility to adjust the timeout values to better suit your operation needs.
	You ignored a low battery alarm until the battery is dead and your machine has gone into Dead Battery Suspend mode.	Install a power adapter and then push the Power and Suspend/Resume button. (<i>See Power Sources page 25 for more information</i>)
	Your power adapter has failed or lost its power source.	Make sure the adapter is plugged in and the outlet has power.
	You have a battery failure.	Verify the condition of the batteries using the Status Indicator panel, and replace or remove any batteries that are shorted. (<i>See Status Indicator Panel page 15 for more information</i>)
Your LifeBook notebook will not work on battery alone.	The installed batteries are dead.	Replace the battery with a charged one or install an AC adapter.
	No batteries are installed.	Install a charged battery.
	The batteries are improperly installed.	Verify that the batteries are properly connected by re-installing them.

Problem	Possible Cause	Possible Solutions
Your LifeBook notebook will not work on battery alone.	Your installed batteries are faulty.	Verify the condition of the batteries using the Status Indicator panel and replace or remove any batteries that are shorted. (See <i>Status Indicator Panel</i> page 15 for more information)
The batteries seem to discharge too quickly.	You are running an application that uses a great deal of power due to frequent hard drive or DVD/CD-ROM access, or use of a modem or LAN PC card.	Use both the primary battery and an optional second battery and/or use a power adapter for this application when at all possible.
	The power savings features may be disabled.	Check the power management and/or setup utility settings in the Power Savings menu and adjust according to your operating needs.
	The brightness is turned all the way up.	Turn down the brightness adjustment. The higher the brightness the more power your display uses.
	The batteries are very old.	Replace the batteries.
	The batteries have been exposed to high temperatures.	Replace the batteries.
	The batteries are too hot or too cold.	Restore the notebook to normal operating temperature. The Status Indicator panel Charging icon will flash when the battery is out of operating range.
Shutdown and Startup Problems		
The Power and Suspend/Resume button does not work.	The Power and Suspend/Resume button is disabled from the Power -> Advanced submenu of the setup utility.	Enable the button from the setup utility.
	You did not hold the button in long enough.	Hold the button longer. This may need to be a few seconds if your application is preventing the CPU from checking for button pushes.
	There may be a conflict with the application software.	Close all applications and try the button again.
The system powers up and displays power-on information, but fails to load the operating system.	The boot sequence settings of the setup utility are not compatible with your configuration.	Set the operating source by pressing the [ESC] key while the Fujitsu logo is on screen or use the [F2] key and enter the setup utility and adjust the source settings from the Boot menu. (See <i>BIOS Setup Utility</i> page 27 for more information)
	You have a secured system requiring a password to load your operating system.	Make sure you have the right password. Enter the setup utility and verify the Security settings and modify them accordingly. (See <i>BIOS Setup Utility</i> page 27 for more information)
	Internal hard drive was not detected.	Use the BIOS setup utility or Primary Master submenu, located within the Main menu, to try to auto detect the internal hard drive.
Your system display won't turn on when the system is turned on or when the system has resumed.	The system may be password-protected.	Check the status indicator panel to verify that the Security icon is blinking. If it is blinking, enter your password.

Problem	Possible Cause	Possible Solutions
An error message is displayed on the screen during the notebook (boot) sequence.	Power On Self Test (POST) has detected a problem.	See the POST messages to determine the meaning and severity of the problem. Not all messages are errors; some are status indicators. (<i>See Power On Self Test Messages page 61 for more information</i>)
Your notebook appears to change setup parameters when you start it.	BIOS setup changes were not saved when you exited the BIOS setup utility, returning it to previous settings.	Make sure you select Save Changes And Exit when exiting the BIOS setup utility.
	The BIOS CMOS hold-up battery has failed.	Contact your support representative for repairs. This is not a user serviceable part but has a normal life of 3 to 5 years.
Video Problems		
The display is blank when you turn on your notebook.	The display angle and brightness settings are not adequate for your lighting conditions.	Press the [Fn] + [F7] keys repeatedly until you have the desired brightness.
	The LifeBook notebook is set for an external video device only.	Pressing [F10] while holding down the [Fn] key allows you to change your selection of where to send your display video. Each time you press the combination of keys you will step to the next choice. The choices, in order are: built-in display only, external monitor only, both built-in display and external monitor.
	The power management timeouts may be set for very short intervals and you failed to notice the display come on and go off again.	Press any button or key on the keyboard, or move the mouse to restore operation. If that fails, push the Power and Suspend/Resume button. (The display may be shut off by Sleep mode, Auto Suspend or Video Timeout.)
The notebook turned on with a series of beeps and your display is blank.	Power On Self Test (POST) has detected a failure which does not allow the display to operate.	Contact your support representative.
Your system display won't turn on when the system is turned on or when the system has resumed.	The system may be password-protected.	Check the status indicator panel to verify that the Security icon is blinking. If it is blinking, enter your password.
The display goes blank by itself after it is used.	Something is pushing on the Closed Cover switch.	Check the Closed Cover switch. (<i>See Figure on page 8 for location</i>)
	The notebook has gone into Video timeout, Sleep mode, or Save-to-Disk mode because you have not used it for a period of time.	Press any button or key on the keyboard, or move the mouse to restore operation. If that fails, push the power/suspend/resume button. Check your power management settings, or close all applications and go to Power Options control panel.
	The power management timeouts may be set for very short intervals and you failed to notice the display come on and go off again.	Press any button or key on the keyboard, or move the mouse to restore operation. If that fails, push the Power and Suspend/Resume button. (The display may be shut off by Sleep Mode, Auto Suspend or Video Timeout.)

Problem	Possible Cause	Possible Solutions
The built-in display does not close.	A foreign object, such as a paper clip, is stuck between the display and the keyboard.	Remove all foreign objects from the keyboard.
The built-in display has bright or dark spots.	If the spots are very tiny and few in number, this is normal for a large LCD display.	This is normal; do nothing.
	If the spots are numerous or large enough to interfere with your operation needs.	Display is faulty; contact your support representative.
You have connected an external video device and it does not come on.	Your external video device is not compatible with your LifeBook notebook.	See your monitor documentation and the External Monitor Support portions of the Specifications section on page 73.
You have connected an external video device and it does not display any information.	Your BIOS setup is not set to enable your external device.	Toggle the video destination by pressing [Fn] and [F10] together, or check the BIOS setup and enable your external video device. (See Video Features submenu, located within the Advanced Menu of the BIOS.) (See <i>BIOS Setup Utility page 27 for more information</i>)
	Your external video device is not properly installed.	Reinstall your device. (See <i>External Video Port page 49 for more information</i>)
	Your operating system software is not set up with the correct driver for that device.	Check your device and operating system documentation and activate the proper driver.
Miscellaneous Problems		
Error message is displayed on the screen during the operation of an application.	Application software often has its own set of error message displays.	See your application manual and help displays screens for more information. Not all messages are errors some may simply be status.

POWER ON SELF TEST MESSAGES

The following is an alphabetic list of error-and-status messages that Phoenix BIOS and/or your operating system can generate and an explanation of each message. Error messages are marked with an *. The most common errors are marked with a #. If an error message is displayed that is not in this list, write it down and check your operating system documentation both on screen and in the manual. If you can find no reference to the message and its meaning is not clear, contact your support representative for assistance.

nnnn Cache SRAM Passed

Where nnnn is the amount of system cache in kilobytes successfully tested by the Power On Self Test. (This can only appear if you have an SRAM PC Card installed.)

***Diskette drive A error or Diskette drive B error**

Drive A: or B: is present but fails the BIOS Power On Self Test diskette tests. Check to see that the drive is defined with the proper diskette type in the Setup Utility, (*See BIOS Setup Utility page 27 for more information*) and that the diskette drive is installed correctly. If the disk drive is properly defined and installed, avoid using it and contact your support representative.

***Extended RAM Failed at offset: nnnn**

Extended memory not working or configured improperly. If you have an installed memory upgrade module, verify that the module is properly installed. If it is properly installed, check your Windows Setup to be sure it is not using unavailable memory until you can contact your support representative.

nnnn Extended RAM Passed

Where nnnn is the amount of memory in kilobytes successfully tested.

***Failing Bits: nnnn The hex number nnnn**

This is a map of the bits at the memory address (in System, Extended, or Shadow memory) which failed the memory test. Each 1 (one) in the map indicates a failed bit. This is a serious fault that may cause you to lose data if you continue. Contact your support representative.

***Fixed Disk x Failure or Fixed Disk Controller Failure (where x = 1-4)**

The fixed disk is not working or not configured properly. This may mean that the hard drive type identified in your setup utility does not agree with the type detected by the Power On Self Test. Run the setup utility to check for the hard drive type settings and correct them if necessary. If the settings are OK and the message appears when you restart the system, there may be a serious fault which might cause you to lose data if you continue. Contact your support representative.

***Incorrect Drive A type – run SETUP**

Type of floppy drive A: not correctly identified in Setup. This means that the floppy disk drive type identified in your setup utility does not agree with the type detected by the Power On Self Test. Run the setup utility to correct the inconsistency.

***Incorrect Drive B type – run SETUP**

Type of floppy drive B: not correctly identified in Setup. This means that the floppy disk drive type identified in your setup utility does not agree with the type detected by the Power On Self Test. Run the setup utility to correct the inconsistency.

***Invalid NVRAM media type**

Problem with NVRAM access. In the unlikely case that you see this message you may have some display problems. You can continue operating but should contact your support representative for more information.

***Keyboard controller error**

The keyboard controller test failed. You may have to replace your keyboard or keyboard controller but may be able to use an external keyboard until then.

***Keyboard error**

Keyboard not working. You may have to replace your keyboard or keyboard controller but may be able to use an external keyboard until then. Contact your support representative.

***Keyboard error nn**

BIOS discovered a stuck key and displays the scan code for the stuck key. You may have to replace your keyboard but may be able to use an external keyboard until then. Contact your support representative.

***Monitor type does not match CMOS – Run SETUP**

Monitor type not correctly identified in Setup. This error probably means your BIOS is corrupted, run the setup utility and set all settings to the default conditions. If you still get this error, contact your support representative.

#*Operating system not found

Operating system cannot be located on either drive A: or drive C:. Enter the setup utility and see if both the fixed disk, and drive A: are properly identified and that the boot sequence is set correctly. Unless you have changed your installation greatly, the operating system should be on drive C:. If the setup utility is correctly set, your hard drive may be corrupted and your system may have to be reinstalled from your back up media.

***Parity Check 1 nnnn**

Parity error found in the system bus. BIOS attempts to locate the address and display it on the screen. If it cannot locate the address, it displays?????. This is a potentially data-destroying failure. Contact your support representative.

***Parity Check 2 nnnn**

Parity error found in the I/O bus. BIOS attempts to locate the address and display it on the screen. If it cannot locate the address, it displays ????. This is a potentially data destroying failure. Contact your support representative.

****Press <F1> to resume, <F2> to SETUP**

Displayed after any recoverable error message. Press the [F1] key to continue the boot process or the [F2] key to enter Setup and change any settings.

****Previous boot incomplete – Default configuration used**

Previous Power On Self Test did not complete successfully. The Power On Self Test will load default values and offer to run Setup. If the previous failure was caused by incorrect values and they are not corrected, the next boot will likely fail also. If using the default settings does not allow you to complete a successful boot sequence, you should turn off the power with the power/suspend/resume button and contact your support representative.

***Real time clock error**

Real-time clock fails BIOS test. May require board repair. Contact your support representative.

***Shadow RAM Failed at offset: nnnn**

Shadow RAM failed at offset nnnn of the 64k block at which the error was detected. You are risking data corruption if you continue. Contact your support representative.

nnnn Shadow RAM Passed

Where nnnn is the amount of shadow RAM in kilobytes successfully tested.

***System battery is dead – Replace and run SETUP**

The BIOS CMOS RAM memory hold up battery is dead. This is part of your BIOS and is a board mounted battery which requires a support representative to change. You can continue operating but you will have to use setup utility default values or reconfigure your setup utility every time you turn off your LifeBook notebook. This battery has an expected life of 2 to 3 years.

System BIOS shadowed

System BIOS copied to shadow RAM.

***System CMOS checksum bad – run SETUP**

BIOS CMOS RAM has been corrupted or modified incorrectly, perhaps by an application program that changes data stored in BIOS memory. Run Setup and reconfigure the system.

***System RAM Failed at offset: nnnn**

System memory failed at offset nnnn of in the 64k block at which the error was detected. This means that there is a fault in your built-in memory. If you continue to operate, you risk corrupting your data. Contact your support representative for repairs.

nnnn System RAM Passed

Where nnnn is the amount of system memory in kilobytes successfully tested.

***System timer error**

The timer test failed. The main clock that operates the computer is faulty. Requires repair of system board. Contact your support representative for repairs.

UMB upper limit segment address: nnnn

Displays the address of the upper limit of Upper Memory Blocks, indicating released segments of the BIOS memory which may be reclaimed by a virtual memory manager.

Video BIOS shadowed

Video BIOS successfully copied to shadow RAM.

MODEM RESULT CODES

The operating system and application software that is factory installed detects the modem characteristics and provides the necessary command strings to operate the modem. The internal modem operation is controlled by generic AT commands from the operating system and application software. The standard long form result codes may, in some cases, be displayed on your screen to keep you informed of the actions of your modem. The operating system and application software may suppress display of the result codes.

Examples of result codes are:

- OK
- NO CARRIER
- NO DIALTONE
- CONNECT 53000 (Connection complete at 53,000 bps.)
- ERROR
- FAX
- RING (This means an incoming call.)
- BUSY
- NO ANSWER

When using the internal modem with applications that are not factory installed refer to the application documentation.

Restoring Your Pre-installed Software

The Drivers and Applications Restore (DAR) disc contains sets of device drivers and Fujitsu utilities (in specific directories) that are unique to your computer configuration for use as documented below.



If you have access to the internet, visit the Fujitsu Support website at: <http://www.computers.us.fujitsu.com/support> to check for the most current information, drivers and hints on how to perform recovery and system updates.

Re-Installing Individual Drivers and Applications

The Drivers and Applications disc can be used to selectively re-install drivers and/or applications that may have been un-installed or corrupted.



There may be certain free third-party applications pre-installed on your system that are not on the DAR disc. The latest versions of the applications can be downloaded from the third-party's website.

To re-install drivers and/or applications:

1. Boot up the system and insert the DAR disc after Windows has started. A Fujitsu Installer screen is displayed after the disc is inserted.
2. After reading the License Agreement, click [I agree].
3. A window will appear containing a list of applications, drivers, and utilities that you can install from the Drivers and Applications disc.



The components listed are color-coded in terms of their install status. Blue indicates that the component can be installed. Green indicates that the component needs to be installed separately. Grey indicates a component that is already installed; grey items can be reinstalled, but prior to installation you will receive a reminder that the component is already installed.

4. In the list, check off all the components you want to install. If you want to install all components, click [Select All]. Clicking [Select All] will select all of the blue-coded components; you must select grey and green components separately.
5. Once you have selected the components you wish to install, click [Install Selected Subsystems]; the components will be installed.

6. After the components are installed, click [OK], then click [Yes] when asked if you want to reboot the system.

RESTORING THE FACTORY IMAGE



The Recovery and Utility Disc only restores the primary hard disk drive. If you have an optional second hard disk drive installed, **it will not be restored** using these utilities.

The Recovery and Utility Disc that came with your system contains two utilities:

- The **Recovery** utility allows you to restore the original contents of the C: drive.
- The **Hard Disk Data Delete** utility on this disc is used to delete all data on your hard disk and prevent it from being reused. Do not use the Hard Disk Data Delete utility unless you are absolutely certain that you want to erase your entire hard disk, including all partitions.

- The use of this disc requires that you have a device capable of reading DVDs attached to your system. If you do not have a built-in DVD player, you will need to attach an external player. For more information on available external devices, visit our Website at: us.fujitsu.com/computers.



- This disc can only be used with the system with which it was purchased.

BOOT Priority Change

Before restoring an image, you must first verify that your system is set up to boot from the DVD drive. To verify/change the boot-up priority (rather than booting-up from the hard drive or an external floppy disk drive), perform one of the following procedures:

Changing priority from BOOT Menu:

1. Start your system and press the [F12] key when the Fujitsu logo appears. You will open the Boot Menu window.
2. Using the arrow keys, select the device from which you want to boot.
3. Press [Enter]. Note that this is a one-time boot priority. To change the boot priority for a longer period, perform the steps above in "Changing priority from BIOS Setup utility".

Changing priority from BIOS Setup utility:

1. Start your system and press the [F2] key when the Fujitsu logo appears. You will enter the BIOS Setup Utility.
Or..., press the [Enter] key or the left mouse button when the Fujitsu logo appears. The TrustedCore Menu will appear. Select BIOS Setup from the TrustedCore Menu.
2. Using the arrow keys, go to the Boot menu.
3. Arrow down to the Boot Device Priority submenu. Press [Enter].
4. If "Optical Media Drive" or "CD-ROM Drive" is not at the top of the list, arrow down to the drive in the list, and press the space bar (or the + key) to move it to the top of the list (the system attempts to boot from the devices in the order in which they are listed). Note that the BIOS for some systems will indicate "CD-ROM Drive", even when a DVD drive is connected.
5. If you have an *external* DVD drive connected, proceed to the next step; otherwise, proceed to step 7.
6. If you have an external DVD drive connected:
 - Select the Advanced menu in the BIOS window.
 - Scroll down to the USB Features submenu and press the Enter key to open it.
 - If Legacy USB Support is disabled, press the space bar to enable it.
 - Scroll down to SCSI SubClass Support and press the space bar to enable it.
7. Press [F10], then click on [Yes] to exit the BIOS Setup Utility and return to the boot process.

Restoring the backup image

After you have changed the boot priority, you can restore a backup image when you are booting up.

Procedure

1. Turn on the power to your system.
2. Ensure that you have a device that can read DVDs either installed in your system or attached externally to it.
3. Insert the Recovery and Utility Disc into the drive tray.
4. Reboot your system.
5. After the system reboots, follow the instructions that appear to either restore your system image or erase all data from your hard disk.

AUTOMATICALLY DOWNLOADING DRIVER UPDATES

Your system has a convenient tool called the Fujitsu Driver Update (FDU) utility. With FDU, you can choose to automatically or manually go to the Fujitsu site to check for new updates for your system.

The FDU icon  should appear in the system tray at the bottom right of your screen (roll the cursor over the icons to find the correct one). If the FDU icon does not appear in the system tray, it can be started by going to [Start] -> All Programs, and clicking on Fujitsu Driver Update; this will create the icon automatically.

To invoke the FDU menu, right-click on the FDU icon. The menu contains the following items:

- **Check for updates now**
Allows for manual driver update search. The first time it is used, you are prompted to agree to a user agreement. After clicking on the icon, the FDU automatically connects with the Fujitsu site to check for updates and downloads them. While downloading, the icon has a red bar through it, indicating that it cannot be used while the download is in process. When the update is complete, a message appears informing you of the fact.
- **Enable Automatic Update Notifications**
Automatically searches for new updates on a regular basis (approximately every 3 days).
- **Show update history**
Brings up a screen that displays a history of updates that have been made via the FDU.
- **About Fujitsu Driver Update**
Displays the FDU version number and copyright information
- **Fujitsu Driver Update Readme**
Displays the FDU readme.



Care and Maintenance

Care and Maintenance

If you use your LifeBook notebook carefully, you will increase its life and reliability. This section provides some tips for looking after the notebook and its devices.



- The system contains components that can be severely damaged by electrostatic discharge (ESD). To minimize risk to the components, observe the following precautions:
 - Before docking or undocking your LifeBook notebook (when using a port replicator), it is a good practice to always touch a grounded metal object to discharge static electricity built up in your body.
 - Be sure to power down your system before adding or removing system components. Even if the system is in hibernate or Sleep states, data could be lost or memory could be damaged if power is still available to the system.
 - When installing or removing a memory module, hold it by the edge so as not to touch any contacts or chips. Be careful not to touch any internal computer terminals or components; the oil from your fingers could cause a short to the components.
 - Electrical equipment may be hazardous if misused. Operations of this product or similar products, must always be supervised by an adult. Do not allow children access to the interior of any electrical products and do not permit them to handle any cables.

LIFEBOOK NOTEBOOK

Caring for your Notebook

- Your LifeBook notebook is a durable but sensitive electronic device. Treat it with care.
- Make a habit of transporting it in a carrying case.
- Do not attempt to service the computer yourself.
- Always follow installation instructions closely.
- To protect your notebook from damage and to optimize system performance, be sure to **keep all air all vents unobstructed, clean, and clear of debris**. This may require periodic cleaning, depending upon the environment in which the system is used.
- Do not operate the notebook in areas where the air vents can be obstructed, such as in tight enclosures or on soft surfaces like a bed or cushion.
- Keep it away from food and beverages.
- If you accidentally spill liquid on your notebook:
 - Turn it off and position it so the liquid can run out.
 - Let it dry out for 24 hours, or longer if needed.
 - If your notebook will not boot after it has dried out, call your support representative.
- Do not use your LifeBook notebook in a wet environment (near a bathtub, swimming pool).
- Always use the AC adapter and batteries that are approved for your LifeBook notebook.
- Avoid exposure to sand, dust and other environmental hazards.
- Do not expose your LifeBook notebook to direct sunlight for long periods of time as temperatures above 140° F (60° C) may damage your notebook.
- Keep the covers closed on the connectors and slots when they are not in use.
- Do not put heavy or sharp objects on the computer.
- If you are carrying your LifeBook notebook in a briefcase, or any other carrying case, make sure that there are no objects in the case pressing on the lid.
- Do not drop your LifeBook notebook.
- Do not touch the screen with any sharp objects.

Cleaning your LifeBook notebook

- Always disconnect the power plug. (Pull the plug, not the cord.)
- Clean your LifeBook notebook with a damp, lint-free cloth. Do not use abrasives or solvents.
- Use a soft cloth to remove dust from the screen. Never use glass cleaners.

Storing your LifeBook notebook





- If storing your LifeBook notebook for a month or longer, turn your LifeBook off and remove all Lithium ion batteries.
- Store your LifeBook notebook and batteries separately. If you store your notebook with a battery installed, the battery will discharge, and battery life will be reduced. In addition, a faulty battery might damage your notebook.
- Store your notebook in a cool, dry location. Temperatures should remain between 13°F (-25°C) and 140°F (60°C).

Traveling with your LifeBook notebook

- Do not transport your LifeBook notebook while it is turned on.
- Do not check your LifeBook notebook as baggage. Carry it with you.
- When traveling with the hard drive removed, wrap the drive in a non-conducting materials (cloth or paper). If you have the drive checked by hand, be ready to

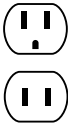
install the drive if needed. Never put your hard drive through a metal detector. Have your hard drive hand-inspected by security personnel. You can however, put your hard drive through a properly tuned X-ray machine.

- Take the necessary plug adapters if you're traveling overseas. Check the following diagram to determine which plug adapter you'll need or ask your travel agent.

Outlet Type	Location
	United States, Canada, Mexico, parts of Latin America, Japan, Korea, the Philippines, Taiwan
	Russia and the Commonwealth of Independent States (CIS), most of Europe, parts of Latin America, the Middle East, parts of Africa, Hong Kong, India, most of South Asia
	United Kingdom, Ireland, parts of Africa, Malaysia, Singapore
	China, Australia, New Zealand

BATTERIES

Caring for your Batteries

- Always handle batteries carefully.
- Do not short-circuit the battery terminals (that is, do not touch both terminals with a metal object). Do not carry loose batteries in a pocket or purse where they may mix with coins, keys, or other metal objects. Doing so may cause an explosion or fire.
- Do not drop, puncture, disassemble, mutilate or incinerate the battery.
- Recharge batteries only as described in this manual and only in ventilated areas.
- Do not leave batteries in hot locations for more than a day or two. Intense heat can shorten battery life.
- Do not leave a battery in storage for longer than six months without recharging it.

Increasing Battery Life

- Power your LifeBook notebook through the AC adapter whenever possible.
- If your LifeBook notebook is running on battery power all day, connect it to the AC adapter overnight to recharge the battery.
- Keep brightness to the lowest level comfortable.

- Set the power management for maximum battery life.
- Put your LifeBook notebook in Sleep mode when it is turned on and you are not actually using it.
- Minimize your DVD/CD-RW drive, CD-ROM drive, and wireless LAN usage.
- Disable the Windows CD Auto Insert function.
- Always use fully charged batteries.
- Eject PCMCIA cards when not in use.

FLOPPY DISKS AND DRIVES

Caring for your Floppy Disks

- Avoid using floppy disks in damp or dusty locations.
- Never store floppy disks near a magnet or magnetic field.
- Do not use a pencil or an eraser on a disk or disk label.
- Avoid storing the floppy disks in extremely hot or cold locations, or in locations subject to severe temperature changes. Store at temperatures between 50° F (10°C) and 125° F (52°C).
- Do not touch the exposed part of the disk behind the metal shutter.

Caring for your Floppy Disk Drive

- To clean, wipe the floppy disk drive clean with a dry soft cloth, or with a soft cloth dampened with water or a solution of neutral detergent. Never use benzene, paint thinner or other volatile material.
- Avoid storing the floppy disk drive in extremely hot or cold locations, or in locations subject to severe temperature changes. Store at temperatures between 50° F (10°C) and 125° F (52°C).
- Keep the floppy disk drive out of direct sunlight and away from heating equipment.
- Avoid storing the floppy disk drive in locations subject to shock and vibration.
- Never use the floppy disk drive with any liquid, metal, or other foreign matter inside the floppy disk drive or disk.
- Never disassemble or dismantle your floppy disk drive.

DVDs AND CDs

Caring for your DVDs and CDs

DVDs and CDs are precision devices and will function reliably if given reasonable care.

- Always store your DVD/CDs in its case when it is not in use.
- Always handle DVD/CDs by the edges and avoid touching the surface.

- Avoid storing any DVD/CDs in extreme temperatures.
- Do not bend DVD/CDs or set heavy objects on them.
- Do not spill liquids on DVD/CDs.
- Do not scratch DVD/CDs.
- Do not put a label on DVD/CDs.
- Do not get dust on DVD/CDs.
- Never write on the label surface with a ballpoint pen or pencil. Always use a felt pen.
- If a DVD/CD is subjected to a sudden change in temperature, cold to warm, condensation may form on the surface. Wipe the moisture off with a clean, soft, lint free cloth and let it dry at room temperature. DO NOT use a hair dryer or heater to dry DVD/CDs.
- If a DVD/CD is dirty, use only a DVD/CD cleaner or wipe it with a clean, soft, lint free cloth starting from the inner edge and wiping to the outer edge.

Caring for your Media Drive

Your media drive is durable but you must treat it with care. Please pay attention to the following points:

- The drive rotates the compact disk at a very high speed. Do not carry it around or subject it to shock or vibration with the power on.
- Avoid using or storing the drive where it will be exposed to extreme temperatures.
- Avoid using or storing the drive where it is damp or dusty.
- Avoid using or storing the drive near magnets or devices that generate strong magnetic fields.
- Avoid using or storing the drive where it will be subjected to shock or vibration.
- Do not disassemble or dismantle the media drive.

PC CARDS/EXPRESSCARDS

Caring for your Cards

PC Cards and ExpressCards are durable, but you must treat them with care. The documentation supplied with your card will provide specific information, but you should pay attention to the following points:

- To keep out dust and dirt, store cards in their protective sleeves when they are not installed in your LifeBook notebook.
- Avoid prolonged exposure to direct sunlight or excessive heat.
- Keep the cards dry.
- Do not flex or bend the cards, and do not place heavy objects on top of them.
- Do not force cards into the slot.
- Avoid dropping cards, or subjecting them to excessive vibration.



7
**System
Specifications**

Specifications

This section provides the general hardware and environmental specifications for your LifeBook notebook. Specific details about your system may vary from those referenced here. For an updated list of current configurations, please go to the Fujitsu Computer Systems Corporation Website at: us.fujitsu.com/computers.



All options listed are accurate as of the date of print; substitutions may have been made subsequent to date of publication.

CONFIGURATION LABEL

Your LifeBook notebook contains a configuration label located on the bottom of the system. This label contains specific information regarding the options you've chosen for your notebook. Following is an example label and information about its various parts. Your label may vary, depending upon your system configuration.

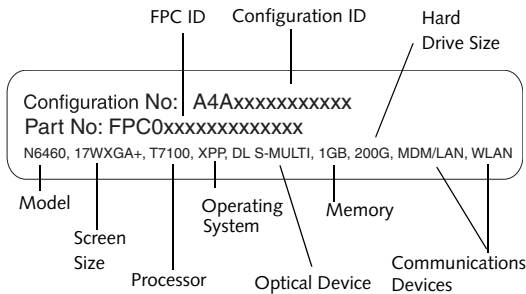

Figure 7-1 Configuration Label

MICROPROCESSOR

Intel® Core™ 2 Duo processor. To determine the type and speed of your processor, right-click My Computer, select Properties, then select the General tab, or check the configuration label (Figure 7-1).

Cache Memory

Depending upon the system processor, cache memory is 2 MB or 4 MB cache on-die

MEMORY

- Factory-installed maximum is 4 GB. If purchased with less than the maximum, the user can purchase larger and/or additional modules.
- DDR2-667 MHz, PC5300
- 2 DIMM slots
- Supports dual-channel memory (requires that two DIMM modules be installed)
- Optional 1 GB Turbo Memory module

VIDEO

- Built-in 17" Color Enhanced Crystal View flat-panel Wide XGA+ TFT active matrix Crystal View (high contrast: 600:1 contrast ratio; high brightness: 370 nits) LCD display with simultaneous display capability.
- Visual Optimizer button to dynamically and automatically enhance video images for optimal quality.

Video Color and Resolution

- **Internal:** WXGA+, 1440 x 900 pixel resolution, 16M colors max
- **External:** 1600 x 1200 pixel resolution, 16M colors.
- **Simultaneous:** 1024 x 768 pixel resolution, 16M colors max

Graphics Accelerator Card

- ATI Mobility™ Radeon™ HD 2600 graphics with 512 MB of HyperMemory™ (256 MB dedicated video memory and 256 MB shared memory)

AUDIO

The Intel PM965 controller supports Intel High Definition (HD) Audio. HD Audio delivers the features and high-end performance of an add-in audio card, and is capable of playing back more channels of higher quality than was previously possible.

- ALC262
- Stereo headphone/SPDIF jack, 1 V_{rms} or less, minimum impedance 32 Ohms
- Stereo microphone jack, 100mV_{rms} or less, minimum impedance 10K Ohms
- Two built-in stereo box speakers (1.5W/channel) and subwoofer

MASS STORAGE DEVICES

Hard Disk Drives

- Optional second hard disk drive (Note that the optional second hard disk drive is a factory-installed option, and cannot be purchased as an accessory.)
- Hard Disk Drive configurations available: (Note that all hard disk drives are Serial-ATA)
 - 100 GB (5400 rpm)
 - 100 GB (7200 rpm)
 - 200 GB (4200 rpm)
 - 250 GB (4200 rpm)
- 100 GB (7200 rpm) + 100 GB (7200 rpm) = 200 GB
- 200 GB (4200 rpm) + 200 GB (4200 rpm) = 400 GB
- 250 GB (4200 rpm) + 250 GB (4200 rpm) = 500 GB

Optical Drive

- **Dual-Layer Multi-Format DVD Writer:** Read - 24x CD-ROM, 24x CD-R, 24x CD-RW, 8x DVD-ROM, 8x DVD-R, 4x DVD-R DL, 6x DVD-RW, 8x DVD+R, 4x DVD+R DL, 8x DVD+RW, 5x DVD-RAM

Write - 24x CD-R, 10x CD-RW, 8x DVD-R, 4x DVD-R DL, 6x DVD-RW, 8x DVD+R, 4x DVD+R DL, 8x DVD+RW, 5x DVD-RAM, or,

▪ **Blu-ray DVD Player:**

Read - 24x CD-ROM, 24x CD-R, 24x CD-RW, 8x DVD-ROM, 8x DVD-R, 6x DVD-R DL, 6x DVD-RW, 8x DVD+R, 6x DVD+R DL, 6x DVD+RW, 5x DVD-RAM, 1.6x BD-ROM, 1x BD-R, 1x BD-R DL, 1x BD-RE, 1x BD-RE DL

Write - 8x CD-R, 10x CD-RW, 8x DVD-R, 2x DVD-R DL, 4x DVD-RW, 8x DVD+R, 2.4x DVD+R DL, 4x DVD+RW, 5x DVD-RAM, 1x BD-R, 1x BD-R DL, 1x BD-RE, 1x BD-RE DL

FEATURES

Integrated Pointing Device

Touchpad, with two buttons and a fingerprint recognition sensor/scroll button

Theft Prevention Lock Slot

Lock slot for use with physical restraint security systems.

Biometric Security

Fingerprint recognition sensor helps to guard against unauthorized system access.

Communications

- Integrated Broadcom 10 Base-T/100 Base-TX/1000 Base-T Gigabit Ethernet LAN
- Internal V.90 standard 56K* fax/modem (ITU V.90, 56K data, 14.4K fax).
- Intel® Wireless Wi-Fi Link 4965AGN (quad-mode 802.11a/b/g/draft-N) or Intel Pro/Wireless 3945ABG Network Connection (802.11a/b/g)

* Actual data transfer rate over U.S. telephone lines varies and is less than 56Kbps due to the current FCC regulations and line conditions.

DEVICE PORTS

- PC Card slot for one Type II cards: PCMCIA Standard 2.1 with CardBus support
- ExpressCard slot for one ExpressCard (supporting either 34mm or 54mm ExpressCards)
- One 15-pin D-SUB connector for VGA external monitor or LCD projector (see Display specifications)
- Combination Memory Stick/Secure Digital (SD)/xD Card slot
- One mini-DIN 7-pin S-Video Out port
- Five connectors for USB 2.0 (Universal Serial Bus) input/output devices
- One HDMI port
- One 4-pin IEEE 1394 jack
- One stereo microphone/line in jack (See Audio specifications)
- One stereo headphone/line out jack (See Audio specifications)
- One modular modem (RJ-11) connector
- One modular LAN (RJ-45) connector

KEYBOARD

Built-in keyboard with all functions of 103 key keyboards.

- Total number of keys: 103
- Function keys: 12, [F1] through [F12]
- Feature extension key: [Fn]
- Windows keys: 2 (Start key and Application key)
- Key pitch: 19 mm
- Key stroke: 3.0 mm
- Dedicated ten-key numeric keypad
- Built-in Alps Wide Touchpad pointing device with left and right buttons and scrolling button

External Keyboard and Mouse Support

USB-compatible

Management Standard

DMI 2.0-ready, WFM 2.0-compliant

POWER

Batteries

Main 6-cell Lithium ion battery, rechargeable, 10.8V, 3200 mAh

Adapters

AC Adapter: Autosensing 100-240V AC, 100W, supplying 19V DC, 5.27A, to the LifeBook notebook (includes an AC cable).

Power Management

Conforms to ACPI (Advanced Configuration & Power Interface)

DIMENSIONS

Overall Dimensions

15.87" x 11.61" x 1.79"/2.02"
(403 mm x 295 mm x 45.5/51.3 mm)

Weight

Non-TV tuner model (with one hard disk drive):
Approximately 9.92 lbs. (4.5 Kg)

TV tuner model (with one hard disk drive):
Approximately 10.12 lbs. (4.59 Kg)

TV tuner model (with two hard disk drives):
Approximately 10.58 lbs. (4.8 Kg)

ENVIRONMENTAL REQUIREMENTS

Temperature

Operating: 5° to 35° C (41° to 95° F)
Non-operating: -15° to 60° C (5° to 140° F)

Humidity

Operating: 20% to 85%, relative, non-condensing.
Non-operating: 8% to 85%, relative, non-condensing

Altitude

Operating: 10,000 feet (3,048 m) maximum

POPULAR ACCESSORIES

For information on ordering Fujitsu accessories, please visit our Website at: www.shopfujitsu.com or call 1-877-372-3473.

PRE-INSTALLED SOFTWARE

Depending on your pre-installed operating system, your Fujitsu LifeBook notebook comes with pre-installed software for playing audio and video files of various formats. In addition there is file transfer software, virus protection software and Power Management software. The following list indicates the pre-installed software associated with your system (depending upon your operating system).

- Adobe Reader
- EverNote (on select models)
- Fujitsu Driver Update utility
- Fujitsu HotKey
- Google Desktop
- Google Tool Bar
- LifeBook Application Panel
- Microsoft Works 8.5 Trial Edition (on select models)
- Microsoft Office Home and Student 2007 Edition (on Windows Vista Home Premium models)
- Microsoft Office Small Business 2007 Edition (on Vista Business and Vista Ultimate models)
- OmniPass Fingerprint Recognition Utility
- Symantec Norton Internet Security 2007 (90-day free trial).
- CyberLink MakeDisc
- CyberLink PowerProducer
- CyberLink PowerDVD
- Roxio Easy Media Creator

The following software is not pre-installed, but is located on the software CD that came with your system (as noted):

- CyberLink PowerDVD for Blu-ray (Blu-ray models only)

LEARNING ABOUT YOUR SOFTWARE

Tutorials

All operating systems and most application software have tutorials built into them. We recommend that you step through the tutorial before you use an application.

Manuals

Included with your notebook you will find manuals for your installed operating system and other pre-installed software; some of the manuals may be installed in the applications Help menu. We recommend that you review these manuals for general information on the use of these applications.

Adobe Acrobat Reader

The Adobe Acrobat Reader allows you to view, navigate, and print PDF files from across all of the major computing platforms.

CyberLink PowerDVD

PowerDVD from CyberLink is a versatile DVD player software application. PowerDVD provides high-quality video and audio playback on your system.

EverNote

EverNote allows you to easily capture, store and access a variety of documents, such as typed and handwritten memos, webpage excerpts, emails, phone messages, addresses, passwords, sketches, and documents.

Fujitsu Driver Update Utility

The Fujitsu Driver Update (FDU) utility is pre-installed on your system. With FDU, you can choose to automatically or manually go to the Fujitsu site to check for new updates for your system. (*See Automatically Downloading Driver Updates on page 59 for more information*)

Fujitsu HotKey

Fujitsu HotKey allows you to control the display brightness of your notebook in order to maximize battery life.

Google Desktop

Google Desktop lets you to search the contents of your computer for emails, web history, and files. It also allows you to view news and photos from anywhere on your desktop.

Google Toolbar

Google Toolbar lets you to search the Internet quickly, block pop-ups, and perform a variety of other tasks to make your Internet experience easier and more pleasant.

LifeBook Application Panel Software

Your LifeBook is pre-installed with software utilities that let you operate and configure your LifeBook Application Panel. The Application Panel utilities are found under Start -> Settings -> Control Panel -> Application Panel.

OmniPass Fingerprint Recognition Software

The fingerprint sensor uses Softex OmniPass which provides password management capabilities to Microsoft Windows operating systems. OmniPass lets you use a "master password" for all Windows, applications, and on-line passwords, and presents a convenient user interface through which you can securely manage passwords, users, and multiple identities for each user.

Norton Internet Security™ from Symantec

Your system is pre-installed with a free 90-day trial version of Symantec's Norton Internet Security™. Internet Security is designed to protect your notebook from computer viruses. It assists in protection of the data currently on your hard disk from contamination or destruction. The trial version is activated upon acceptance of software license agreement. After 90 days, you must purchase a subscription from Symantec to download the latest definitions. (*See online help or manual for more information on how and when to run this program*)

Operating System Options

Depending upon your system, one of the following operating system configurations will be installed:

Microsoft Windows Vista Home Premium Edition

With Microsoft Works 8.5 and Microsoft Office (Home and Student Edition 2007)

Microsoft Windows Vista Business Edition

With Microsoft Works 8.5 and Microsoft Office 60-day trial (Small Business Edition 2007)

Microsoft Windows Vista Ultimate Edition

With Microsoft Works 8.5 and Microsoft Office 60-day trial (Small Business Edition 2003)

▪ Microsoft Works 8.5

Microsoft Works 8.5 is a software suite containing the basic tools to write letters and reports, track family and friends with address books, manage home finances, and create a home inventory.

▪ Microsoft Office Home and Student Edition 2007

(Optional with Microsoft Windows Vista Home Premium Edition) Microsoft Office Home and Student 2007 is easy-to-use software to make you more productive in a home and/or school environment. Microsoft Office Home and Student 2007 includes Microsoft Word, Excel, PowerPoint, and OneNote.

▪ Office Microsoft Small Business Edition 2007

(Optional with Microsoft Windows Vista Business and Vista Ultimate Editions) Microsoft Office 2007 Small Business Edition is easy-to-use software to help you manage business opportunities more effectively, create marketing materials, manage e-mail, and share information. Microsoft SBE includes Microsoft Word, Excel, Outlook, PowerPoint, Publisher, and Business Contact Manager.

A large, light gray, stylized number 8 logo that serves as a background for the page number. The number 8 is bold and black, positioned centrally within the upper loop of the logo.

8

Glossary

Glossary

AC Adapter

A device which converts the AC voltage from a wall outlet to the DC voltage needed to power your LifeBook notebook.

Active-Matrix Display

A type of technology for making flat-panel displays which has a transistor or similar device for every pixel on the screen.

BIOS

Basic Input-Output System. A program and set of default parameters stored in ROM which tests and operates your LifeBook notebook when you turn it on until it loads your installed operating system from disk. Information from the BIOS is transferred to the installed operating system to provide it with information on the configuration and status of the hardware.

Bit

An abbreviation for binary digit. A single piece of information which is either a one (1) or a zero (0).

bps

An abbreviation for bits per second. Used to describe data transfer rates.

Boot

To start-up a computer and load its operating system from disk, ROM or other storage media into RAM.

Bus

An electrical circuit which passes data between the CPU and the sub-assemblies inside your LifeBook notebook.

Byte

8 bits of parallel binary information.

Cache Memory

A block of memory built into the microprocessor which is much faster to access than your system RAM and used in specially structured ways to make your overall data handling time faster.

CardBus

A faster, 32-bit version of the PC Card interface which offers performance similar to the 32-bit PCI architecture.

Command

An instruction which you give your operating system. Example: run a particular application or format a floppy disk.

Configuration

The combination of hardware and software that makes up your system and how it is allocated for use.

CRT

Cathode Ray Tube. A display device which uses a beam of electronic particles striking a luminescent screen. It produces a visual image by varying the position and intensity of the beam.

Data

The information a system stores and processes.

DC

Direct current. A voltage or current that does not fluctuate periodically with time.

DDR

Double Data Rate

Fast version of SDRAM that provides twice the bandwidth of standard SDRAMs.

Default Value

A pre-programmed value to be used if you fail to set your own.

DIMM

Dual-in-line memory module.

DISE

Drive Image Special Edition (DISE) by PowerQuest. Provides a way to restore your computer if you experience a hard disk crash or other system failure. DISE is used to restore the factory image and restore the system to its original state.

Disk

A spinning platter of magnetic data storage media. If the platter is very stiff it is a hard drive, if it is highly flexible it is a floppy disk, if it is a floppy disk in a hard housing with a shutter it is commonly called a diskette.

Disk Drive

The hardware which spins the disk and has the heads and control circuitry for reading and writing the data on the disk.

Diskette

A floppy disk in a hard housing with a shutter.

DMA

Direct Memory Access. Special circuitry for memory to memory transfers of data which do not require CPU action.

DOS

Disk Operating System (MS-DOS is a Microsoft Disk Operating System).

Driver

A computer program which converts application and operating system commands to external devices into the exact form required by a specific brand and model of device in order to produce the desired results from that particular equipment.

DVD

Digital Video Disc. This is a form of optical disc storage for video, audio and computer data, envisioned to replace current digital storage formats (CD-ROM, laser and audio CD) because of its capability for storing greater amounts of data. A typical single layer, single-sided DVD, for example, can contain 4.7GB of data and a maximum of 17GB for the double-sided discs.

ECP

Extended Capability Port. A set of standards for high speed data communication and interconnection between electronic devices.

ESD

Electrostatic Discharge. The sudden discharge of electricity from a static charge which has built up slowly. Example: the shock you get from a doorknob on a dry day or the sparks you get from brushing hair on a dry day.

Extended Memory

All memory more than the 640KB recognized by MS-DOS as system memory.

FCC

Federal Communication Commission.

Floppy Disk

A spinning platter of magnetic data storage media which is highly flexible.

GB

Gigabyte.

Hard drive

A spinning platter of magnetic data storage media where the platter is very stiff.

Hexadecimal

A decimal notation for the value of a 4 bit binary number. (0-9, A, B, C, D, E, F) Example: 2F in hexadecimal = 00101111 in binary = 47 in decimal.

I/O

Input/Output. Data entering and leaving your LifeBook notebook in electronic form.

I/O Port

The connector and associated control circuits for data entering and leaving your LifeBook notebook in electronic form.

IDE

Intelligent Drive Electronics. A type of control interface for a hard drive which is inside the hard drive unit.

IEEE 1394

A type of data transfer protocol that allows for fast transfer of digital files and data with devices such as digital cameras.

IRQ

Interrupt Request. An acronym for the hardware signal to the CPU that an external event has occurred which needs to be processed.

KB

Kilobyte.

LAN

Local Area Network. An interconnection of computers and peripherals within a single limited geographic location which can pass programs and data amongst themselves.

LCD

Liquid Crystal Display. A type of display which makes images by controlling the orientation of crystals in a crystalline liquid.

Lithium ion Battery

A type of rechargeable battery which has a high power-time life for its size and is not subject to the memory effect as Nickel Cadmium batteries.

MB

Megabyte.

Megahertz

1,000,000 cycles per second.

Memory

A repository for data and applications which is readily accessible to your LifeBook notebook's CPU.

MHz

Megahertz.

MIDI

Musical Instrument Digital Interface. A standard communication protocol for exchange of information between computers and sound producers such as synthesizers.

Modem

A contraction for MODulator-DEModulator. The equipment which connects a computer or other data terminal to a communication line.

Monaural

A system using one channel to process sound from all sources.

MVA

Multi-Domain Vertical Alignment. A display technology that allows a wider viewing angle than traditional displays, similar to a CRT.

NTSC

National TV Standards Commission. The standard for TV broadcast and reception for the USA.

Operating System

A group of control programs that convert application commands, including driver programs, into the exact form required by a specific brand and model of micro-processor in order to produce the desired results from that particular equipment.

Parallel Port

A connection to another device through which data is transferred as a block of bits simultaneously with a wire for each bit in the block and with other wires only for control of the device not for transfer of data.

Partition

A block of space on a hard drive which is set aside and made to appear to the operating system as if it were a separate disk, and addressed by the operating system accordingly.

PCMCIA

PCMCIA is a trademark of the Personal Computer Memory Card International Association. The Personal Computer Memory Card International Association is an

organization that sets standards for add-in cards for personal computers.

Peripheral Device

A piece of equipment which performs a specific function associated with but not integral to a computer. Examples: a printer, a modem, a CD-ROM.

Pitch (keyboard)

The distance between the centers of the letter keys of a keyboard.

Pixel

The smallest element of a display, a dot of color on your display screen. The more pixels per area the clearer your image will appear.

POST

Power On Self Test. A program which is part of the BIOS which checks the configuration and operating condition of your hardware whenever power is applied to your LifeBook notebook. Status and error messages may be displayed before the operating system is loaded. If the self test detects failures that are so serious that operation can not continue, the operating system will not be loaded.

Program

An integrated set of coded commands to your computers telling your hardware what to do and how and when to do it.

RAM

Random Access Memory. A hardware component of your LifeBook notebook that holds binary information (both program and data) as long as it has the proper power applied to it.

RAM Module

A printed circuit card with memory and associated circuitry which allows the user to add additional memory to the computer without special tools.

Reset

The act of reloading the operating system. A reset erases all information stored in RAM.

Restart

See Reset.

Resume

To proceed after interruption. In your LifeBook notebook this refers to returning to active operation after having been in one of the suspension states.

ROM

Read Only Memory. A form of memory in which information is stored by physically altering the material. Data stored in this way can not be changed by your LifeBook notebook and does not require power to maintain it.

SDRAM

Synchronous Dynamic Random Access Memory.

Serial Port

A connection to another device through which data is transferred one bit at a time on a single wire with any other wires only for control of the device not for transfer of data.

Smart Card

Smart Cards are the same size and shape as credit cards, but they contain an integrated microprocessor chip. The chip can hold a variety of different information, and provides the user with many possible options, such as allowing them to make secure purchases, pay for phone calls, store security information, and provide personal identification and information.

SPDIF

Sony Philips Digital Interface Format. The optical digital audio format that allows you to download digital audio onto a MiniDisc recorder or connect to your sound system to play MP3 files with high fidelity sound.

SRAM

Static Random Access Memory. A specific technology of making RAM which does not require periodic data refreshing.

Status Indicator

A display which reports the condition of some portion of your hardware. On your LifeBook notebook this is an LCD screen just above the keyboard.

Stereo (audio)

A system using two channels to process sound from two different sources.

Stroke (keyboard)

The amount of travel of a key when it is pressed from resting to fully depressed.

Suspend

To make inoperative for a period of time. Your LifeBook notebook uses various suspension states to reduce power consumption and prolong the charge of your battery.

SVGA

Super VGA.

S-Video

Super Video. A component video system for driving a TV or computer monitor.

System Clock

An oscillator of fixed precise frequency which synchronizes the operation of the system and is counted to provide time of day and date.

TFT

Thin Film Transistor – A technology for flat display panels which uses a thin film matrix of transistors to control each pixel of the display screen individually.

UL

Underwriters Laboratories – An independent organization that tests and certifies the electrical safety of devices.

VGA

Video Graphics Array. A video display standard originally introduced by IBM with the PS/2 series of personal computers.

VRAM

Video Random Access Memory. A memory dedicated to video display data and control.

WFM

Wired for Management is Intel's broad-based initiative to reduce the total cost of ownership (TCO) of business computing without sacrificing power and flexibility.

Write Protect

Prevent alteration of the binary state of all bits in a storage media. Example: all information on a device such as a floppy diskette; a block of space in a storage media such as a partition of a hard drive; a file or directory of floppy diskette or hard drive.

XGA

Extended VGA.

Regulatory Information

NOTICE

Changes or modifications not expressly approved by Fujitsu could void this user's authority to operate the equipment.

FCC NOTICES

Notice to Users of Radios and Television

This equipment has been tested and found to comply with the limits for a Class B digital device, pursuant to part 15 of the FCC Rules.

These limits are designed to provide reasonable protection against harmful interference in a residential installation. This equipment generates, uses, and can radiate radio frequency energy and, if not installed and used in accordance with the instructions, may cause harmful interference to radio communications. However, there is no guarantee that interference will not occur in a particular installation. If this equipment does cause harmful interference to radio or television reception, which can be determined by turning the equipment off and on, the user is encouraged to try to correct the interference by one or more of the following measures:

- Reorient or relocate the receiving antenna.
- Increase the separation between the equipment and receiver.
- Connect the equipment into an outlet that is on a different circuit than the receiver.
- Consult the dealer or an experienced radio/TV technician for help.

Shielded interconnect cables must be employed with this equipment to ensure compliance with the pertinent RF emission limits governing this device.

Notice to Users of the US Telephone Network

This equipment complies with Part 68 of FCC rules, and the requirements adopted by ACTA. On the bottom of this equipment is a label that contains, among other information, the FCC registration number and ringer equivalence number (REN) for this equipment; or a product identifier in the format US:AAAEQ##TXXXX. If requested, this information or number must be provided to the telephone company.

This equipment is designed to be connected to the telephone network or premises wiring using a standard jack type USOC RJ11C. A plug and jack used to connect this equipment to the premises wiring and telephone network must comply with the applicable FCC Part 68 rules and requirements adopted by the ACTA. A compliant telephone cord and modular plug is provided with this product. It is designed to be connected to a compatible modular jack that is also compliant.

The ringer equivalent number (REN) of this equipment is 0.1B. The REN is used to determine the number of

devices that may be connected to a telephone line. Excessive RENs on a telephone may result in the devices not ringing in response to an incoming call. In most but not all areas, the sum of RENs should not exceed five (5.0). To be certain of the number of devices that may be connected to a line, as determined by the total RENs, contact the local telephone company. For products approved after July 23, 2001, the REN for this product is part of the product identifier that has the format US:AAAEQ##TXXXX. The digits represented by ## are the REN without a decimal point (e.g., 00 is a REN of 0.0). For earlier products, the REN is separately shown on the label.

If this equipment causes harm to the telephone network, the telephone company will notify you in advance that temporary discontinuance of service may be required. But if advance notice isn't practical, the telephone company will notify the customer as soon as possible. Also, you will be advised of your right to file a complaint with the FCC if you believe it is necessary.

The telephone company may make changes in its facilities, equipment, operations or procedures that could affect the operation of the equipment. If this happens, the telephone company will provide advance notice in order for you to make necessary modifications to maintain uninterrupted service.

If trouble is experienced with this equipment, for repair or warranty information, please refer to the manual or contact Fujitsu Computer Systems Corporation, Customer Service. If the equipment is causing harm to the telephone network, the telephone company may request that you disconnect the equipment until the problem is resolved.

The equipment cannot be used on public coin service provided by the telephone company. Connection to party line service is subject to state tariffs. (Contact the state public utility commission, public service commission or corporation commission for information).

If your home has specially wired alarm equipment connected to the telephone line, ensure the installation of this computer does not disable your alarm equipment. If you have any questions about what will disable alarm equipment, consult your telephone company or a qualified installer.

The Telephone Consumer Protection Act of 1991 makes it unlawful for any person to use a computer or other electronic device to send any message via a telephone fax machine unless such message clearly contains in a margin at the top or bottom of each transmitted page or on the first page of the transmission, the date and time it is sent, and an identification of the business or other entity, or other individual sending the message and the telephone number of the sending machine or such business, other entity, or individual.

DOC (INDUSTRY CANADA) NOTICES

Notice to Users of Radios and Television

This Class B digital apparatus meets all requirements of Canadian Interference-Causing Equipment Regulations.

CET appareil numérique de la class B respecte toutes les exigences du Règlement sur le matériel brouilleur du Canada.

Notice to Users of the Canadian Telephone Network

NOTICE: This equipment meets the applicable Industry Canada Terminal Equipment Technical Specifications.

This is confirmed by the registration number. The abbreviation, IC, before the registration number signifies that registration was performed based on a Declaration of Conformity indicating that Industry Canada technical specifications were met. It does not imply that Industry Canada approved the equipment.

Before connecting this equipment to a telephone line the user should ensure that it is permissible to connect this equipment to the local telecommunication facilities. The user should be aware that compliance with the certification standards does not prevent service degradation in some situations.

Repairs to telecommunication equipment should be made by a Canadian authorized maintenance facility. Any repairs or alterations not expressly approved by Fujitsu or any equipment failures may give the telecommunication company cause to request the user to disconnect the equipment from the telephone line.

NOTICE: The Ringer Equivalence Number (REN) for this terminal equipment is 0.1B. The REN assigned to each terminal equipment provides an indication of the maximum number of terminals allowed to be connected to a telephone interface. The termination on an interface may consist of any combination of devices subject only to the requirement that the sum of the Ringer Equivalence Numbers of all the devices does not exceed five.



For safety, users should ensure that the electrical ground of the power utility, the telephone lines and the metallic water pipes are connected together. Users should NOT attempt to make such connections themselves but should contact the appropriate electric inspection authority or electrician. This may be particularly important in rural areas.

Avis Aux Utilisateurs Du Réseau Téléphonique Canadien

AVIS: Le présent matériel est conforme aux spécifications techniques d'Industrie Canada applicables au matériel terminal. Cette conformité est confirmée par le numéro d'enregistrement. Le sigle IC, placé devant le numéro d'enregistrement, signifie que l'enregistrement s'est effectué conformément à une déclaration de conformité et indique que les spécifications techniques d'Industrie Canada ont été respectées. Il n'implique pas qu'Industrie Canada a approuvé le matériel.

Avant de connecter cet équipement à une ligne téléphonique, l'utilisateur doit vérifier s'il est permis de connecter cet équipement aux installations de télécommunications locales. L'utilisateur est averti que même la conformité aux normes de certification ne peut dans certains cas empêcher la dégradation du service.

Les réparations de l'équipement de télécommunications doivent être effectuées par un service de maintenance agréé au Canada. Toute réparation ou modification, qui n'est pas expressément approuvée par Fujitsu, ou toute défaillance de l'équipement peut entraîner la compagnie de télécommunications à exiger que l'utilisateur déconnecte l'équipement de la ligne téléphonique.

AVIS: L'indice d'équivalence de la sonnerie (IES) du présent matériel est de 0.1B. L'IES assigné à chaque dispositif terminal indique le nombre maximal de terminaux qui peuvent être raccordés à une interface téléphonique. La terminaison d'une interface peut consister en une combinaison quelconque de dispositifs, à la seule condition que la somme d'indices d'équivalence de la sonnerie de tous les dispositifs n'excède pas 5.



Pour assurer la sécurité, les utilisateurs doivent vérifier que la prise de terre du service d'électricité, les lignes téléphoniques et les conduites d'eau métalliques sont connectées ensemble. Les utilisateurs NE doivent PAS tenter d'établir ces connexions eux-mêmes, mais doivent contacter les services d'inspection d'installations électriques appropriés ou un électricien. Ceci peut être particulièrement important en régions rurales.



Appendix A

Integrated Wireless LAN* User's Guide

***Optional Device**

FC FCC REGULATORY INFORMATION

Please note the following regulatory information related to the optional wireless LAN device.

Regulatory Notes and Statements

Wireless LAN, Health and Authorization for use

Radio frequency electromagnetic energy is emitted from Wireless LAN devices. The energy levels of these emissions, however, are far much less than the electromagnetic energy emissions from wireless devices such as mobile phones. Wireless LAN devices are safe for use by consumers because they operate within the guidelines found in radio frequency safety standards and recommendations. The use of Wireless LAN devices may be restricted in some situations or environments, such as:

- On board an airplane, or
- In an explosive environment, or
- In situations where the interference risk to other devices or services is perceived or identified as harmful.

In cases in which the policy regarding use of Wireless LAN devices in specific environments is not clear (e.g., airports, hospitals, chemical/oil/gas industrial plants, private buildings), obtain authorization to use these devices prior to operating the equipment.

Regulatory Information/Disclaimers

Installation and use of this Wireless LAN device must be in strict accordance with the instructions included in the user documentation provided with the product. Any changes or modifications made to this device that are not expressly approved by the manufacturer may void the user's authority to operate the equipment. The manufacturer is not responsible for any radio or television interference caused by unauthorized modification of this device, or the substitution or attachment of connecting cables and equipment other than those specified by the manufacturer. It is the responsibility of the user to correct any interference caused by such unauthorized modification, substitution or attachment. The manufacturer and its authorized resellers or distributors will assume no liability for any damage or violation of government regulations arising from failure to comply with these guidelines.

Federal Communications Commission statement

This device complies with Part 15 of FCC Rules.

Operation is subject to the following two conditions: (1) This device may not cause interference, and, (2) This device must accept any interference, including interference that may cause undesired operation of this device.

For operation within 5.15 ~ 5.25 GHz frequency range, it is restricted to indoor environments, and the antenna of this device must be integral.

FCC Interference Statement

This equipment has been tested and found to comply with the limits for a Class B digital device, pursuant to Part 15 of the FCC Rules. These limits are designed to provide reasonable protection against harmful interference in a residential installation. This equipment generates, uses, and can radiate radio frequency energy. If not installed and used in accordance with

the instructions, it may cause harmful interference to radio communications. However, there is no guarantee that interference will not occur in a particular installation.

If this equipment does cause harmful interference to radio or television reception, which can be determined by turning the equipment off and on, the user is encouraged to try and correct the interference by one or more of the following measures:

1. Reorient or relocate the receiving antenna.
2. Increase the distance between the equipment and the receiver.
3. Connect the equipment to an outlet on a circuit different from the one the receiver is connected to.
4. Consult the dealer or an experienced radio/TV technician for help.

FCC Radio Frequency Exposure statement

This Wireless LAN radio device has been evaluated under FCC Bulletin OET 65C and found compliant with the requirements as set forth in CFR 47 Sections 2.1091, 2.1093, and 15.247 (b) (4) addressing RF Exposure from radio frequency devices. The radiated output power of this Wireless LAN device is far below the FCC radio frequency exposure limits. Nevertheless, this device shall be used in such a manner that the potential for human contact during normal operation is minimized. When using this device, a certain separation distance between antenna and nearby persons must be maintained to ensure RF exposure compliance. In order to comply with RF exposure limits established in the ANSI C95.1 standards, the distance between the antennas and the user should not be less than 20 cm (8 inches).

Export restrictions

This product or software contains encryption code which may not be exported or transferred from the US or Canada without an approved US Department of Commerce export license. This device complies with Part 15 of FCC Rules., as well as ICES 003 B / NMB 003 B. Operation is subject to the following two conditions: (1) this device may not cause harmful interference, and (2) this device must accept any interference received, including interference that may cause undesirable operation. Modifications not expressly authorized by Fujitsu Computer Systems Corporation may invalidate the user's right to operate this equipment.

Canadian Notice

The device for the 5150-5250 MHz band is only for indoor usage to reduce the potential for harmful interference to co-channel mobile satellite systems.

The maximum antenna gain of 6 dBi permitted (for devices in the 5250-5350 MHz and 5470-5725 MHz bands) to comply with the e.i.r.p. limit.

In addition, users are cautioned to take note that high power radars are allocated as primary users (meaning they have priority) of 5250-5350 MHz and 5650-5850 MHz bands and these radars could cause interference and/or damage to LE-LAN devices.

Before Using the Wireless LAN

This manual describes the procedures required to properly set up and configure the integrated Wireless LAN Mini-PCI device (referred to as "WLAN device" in the rest of the manual). Before using the WLAN device, read this manual carefully to ensure it's correct operation. Keep this manual in a safe place for future reference.

Wireless LAN Device Covered by this Document

This document is applicable to systems containing one of the following WLAN devices:

- Intel PRO/Wireless 3945ABG Network Connection (WM3945ABG)
- Intel Wireless WiFi Link 4965AGN (4965AGN)

Characteristics of the WLAN Device

- The WLAN device is a Mini-PCI card attached to the main board of the mobile computer.
- The WLAN device operates in license-free RF bands, eliminating the need to procure an FCC operating license. The WLAN operates in the 2.4GHz Industrial, Scientific, and Medical (ISM) RF band and the lower, middle, and upper bands of the 5GHz Unlicensed National Information Infrastructure (UNII) bands.
- The Intel PRO/Wireless 3945ABG WLAN device is capable of three operating modes, IEEE802.11a, IEEE802.11b and IEEE802.11g.
- The Intel PRO/Wireless 4965ABGN WLAN device is capable of four operating modes, IEEE802.11a, IEEE802.11b, IEEE802.11g, and IEEE802.11n (draft)
- The WLAN device is Wi-Fi certified and operates at the maximum data rate of 540 Mbps (theoretical) in IEEE802.11n (draft) mode; 54 Mbps in IEEE802.11a or IEEE802.11g mode; and 11 Mbps in IEEE802.11b mode.

- The WLAN device supports the following encryption methods - WEP, TKIP, CKIP, and AES encryption.
- The Wireless LAN device is compliant with the following standards: WPA, WPA2, CCX1.0, CCX2.0, CCX3.0, and CCX4.0..

WIRELESS LAN MODES USING THIS DEVICE

Ad Hoc Mode

(See Figure A-1) "Ad Hoc Mode" refers to a wireless network architecture where wireless network connectivity between multiple computers is established without a central wireless network device, typically known as Access Point(s). Connectivity is accomplished using only client devices in a peer-to-peer fashion. That is why Ad Hoc networks are also known as peer-to-peer networks. Ad Hoc networks are an easy and inexpensive method for establishing network connectivity between multiple computers.

Ad Hoc mode requires that the SSID, network authentication, and encryption key settings are identically configured on all computers in the Ad Hoc network.

Access Point (Infrastructure) Mode

(See Figure A-2) Infrastructure mode refers to a wireless network architecture in which devices communicate with wireless or wired network devices by communicating through an Access Point. In infrastructure mode, wireless devices can communicate with each other or with a wired network. Corporate wireless networks operate in infrastructure mode because they require access to the WLAN in order to access services, devices, and computers (e.g., file servers, printers, databases).

Figure A-1. Ad Hoc Mode Network

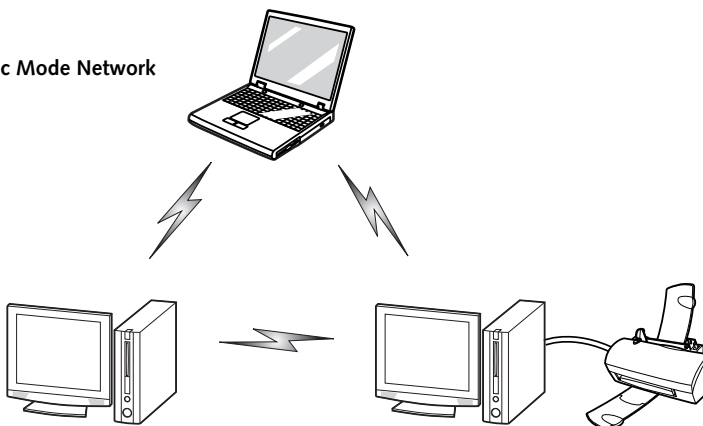

How to Handle This Device

The WLAN device comes pre-installed in your mobile computer. Under normal circumstances, it should not be necessary for you to remove or re-install it. The Operating System that your mobile computer comes with has been pre-configured to support the WLAN device.

- The Intel PRO/Wireless 3945ABG WLAN device supports IEEE802.11a, IEEE802.11b and IEEE802.11g.
- Intel Wireless WiFi Link 4965AGN (4965AGN) device supports IEEE802.11a, IEEE802.11b, IEEE802.11g, and IEEE802.11n (draft).
- The WLAN device operates in the 2.4GHz ISM band and the 5 GHz lower, middle, and upper UNII bands.
- Microwave ovens may interfere with the operation of WLAN devices since they operate in the same 2.4GHz frequency range as IEEE802.11b/g/n devices. Interference by microwaves does not occur with IEEE802.11a radio which operates in the 5 GHz RF band.
- Wireless devices that transmit in the 2.4GHz range may interfere with operation of WLAN devices in IEEE802.11b/g/n modes. Symptoms of interference include reduced throughput, intermittent disconnects, and many frame errors. It is HIGHLY recommended that these interfering devices be powered off to ensure proper operation of the WLAN device.

DEACTIVATING THE WLAN DEVICE

Deactivation of the WLAN device may be desired in certain circumstances (to extend battery life) or where certain environments require it (i.e. hospitals, clinics, airplanes, etc.). To deactivate the WLAN device, use the Wireless On/Off Switch.

Deactivation using the Wireless On/Off Switch

The WLAN device can be deactivated quickly and efficiently by sliding the Wireless On/Off Switch to the Off position. (Figure A-3)

The wireless On/Off switch has no effect on non-Wireless LAN models.

ACTIVATING THE WLAN DEVICE

Activation of the WLAN device can be accomplished using the same methods as the deactivation process, by using the Wireless On/Off Switch”

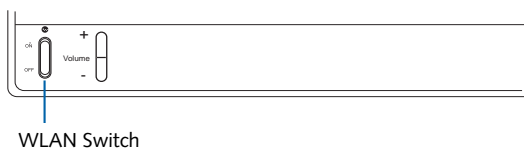
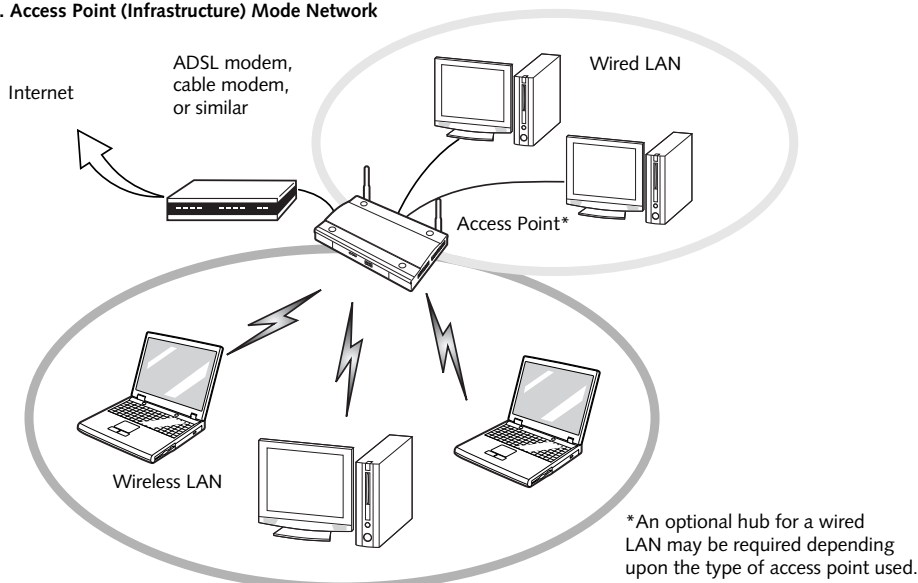

Figure A-3. Wireless LAN On/Off Switch Location

Figure A-2. Access Point (Infrastructure) Mode Network



CONFIGURING THE WLAN

The WLAN device can be configured to establish wireless network connectivity using the software that is built into Windows Vista. Support for most industry standard security solutions is contained in this software.

Pre-defined parameters will be required for this procedure. Please consult with your network administrator for these parameters:

1. Click the Start button, then select Control Panel.
2. If the Control Panel is not in Classic View, select Classic View from the left panel. Double-click the Network and Sharing Center icon.
3. Select "Manage wireless networks" from the left panel.
4. Click on the [Add] button.
5. Depending upon what type of connection you would like to make, make a selection. For an infrastructure network, select "Manually create a network profile. For ad hoc network, select "Create an ad hoc network".
6. Enter the required information. It may be necessary to consult with your network administrator for some of the information.
7. In the event you require assistance, go to the Network and Sharing Center window (Start -> Control Panel -> Network and Sharing Center), and type in relevant keywords in the Search box.

CONNECTING TO A NETWORK

After you have configured your computer, you can connect to an active network by performing the following steps:

1. Click on the WLAN icon in the system tray.
2. Select "connect to a network".
3. Select a network from the list that appears, and click the [Connect] button.

Troubleshooting the WLAN

TROUBLESHOOTING TABLE

Causes and countermeasures for troubles you may encounter while using your wireless LAN are described in the following table.

Problem	Possible Cause	Possible Solution
Unavailable network connection	Incorrect network name (SSID) or network key	<p>Ad hoc connection: verify that the network names (SSID's) and network keys (WEP) of all computers to be connected have been configured correctly. SSID's and WEP key values must be identical on each machine.</p> <p>Access Point (Infrastructure) connection: set the network name (SSID) and network key to the same values as those of the access point.</p> <p>Set the Network Authentication value identically to that of the Access Point. Please consult your network administrator for this value, if necessary.</p>
	Weak received signal strength and/or link quality	<p>Ad hoc connection: Retry connection after shortening the distance to the destination computer or removing any obstacles for better sight.</p> <p>Access Point (Infrastructure) connection: Retry connection after shortening the distance to the access point or removing any obstacles for better sight.</p>
	The WLAN device has been deactivated or disabled	Check if the wireless switch is turned ON. Also verify "Disable Radio" is not checked in "Network setting" window.
	The computer to be connected is turned off	Check if the computer to be connected is turned ON.
	RF interference from Access Points or other wireless networks	The use of identical or overlapping RF channels can cause interference with the operation of the WLAN device. Change the channel of your Access Point to a channel that does not overlap with the interfering device.
	Wireless network authentication has failed	Re-check your Network Authentication, Encryption, and Security settings. Incorrectly configured security settings such as an incorrectly typed WEP key, a misconfigured LEAP username, or an incorrectly chosen authentication method will cause the LAN device to associate but not authenticate to the wireless network.
	Incorrectly configured network settings	Recheck the configuration of your network settings.
	Incorrect IP address configuration	This only applies to networks using static IP addresses. Please contact your network administrator for the correct settings.

Wireless LAN Glossary

GLOSSARY

Ad Hoc Mode

Ad Hoc Mode refers to a wireless network architecture where wireless network connectivity between multiple computers is established without a central wireless network device, typically known as Access Points. Connectivity is accomplished using only client devices in a peer-to-peer fashion.

Channel

Range of narrow-band frequencies used by the WLAN device to transmit data. IEEE802.11b/g - 11 channels, 22 MHz wide channels.

DHCP (Dynamic Host Configuration Protocol)

A protocol that provides a means to dynamically allocate IP addresses to computers on a local area network.

DNS (Domain Name System)

A data query service that provides a mechanism with which to translate host names into Internet addresses.

IEEE802.11a

Wireless LAN standard that supports a maximum data rate of 54 Mbps. 802.11a devices operate in the 5 GHz lower and middle UNII bands.

IEEE802.11b

Wireless LAN standard that supports a maximum data rate of 11 Mbps. 802.11b devices operate in the 2.4 GHz ISM band.

Access point

Wireless network device used to bridge wireless and wired network traffic.

IP address

The logical 32-bit host address defined by the Internet Protocol that uniquely identifies a computer on a network. The IP address is usually expressed in dotted decimal notation.

LAN (Local Area Network)

A LAN or Local Area Network is a computer network (or data communications network) which is confined to a limited geographical area.

MAC address (Media Access Control Address)

A MAC address (also called an Ethernet address or IEEE MAC address) is the 48-bit address (typically written as twelve hexadecimal digits, 0 through 9 and A through F, or as six hexadecimal numbers separated by periods or colons, e.g., 0080002012ef, 0:80:0:2:20:ef) which uniquely identifies a computer that has an Ethernet interface.

MTU (Maximum Transmission Unit)

The maximum size of data which can be transmitted at one time in networks including the Internet. In an environment whose maximum size of data is too large to correctly receive data, normal communications can be restored by setting the size of MTU to a smaller value.

Network key

Data that is used for encrypting data in data communication. The personal computer uses the same network key both for data encryption and decryption, therefore, it is necessary to set the same network key as the other side of communication.

Network name (SSID: Service Set Identifier)

When a wireless LAN network is configured, grouping is performed to avoid interference or data theft. This grouping is performed with "Network name (SSID)". In order to improve security, the network key is set allowing no communication unless "Network name (SSID)" coincides with the network key.

Open system authentication

Null authentication method specified in the 802.11 standard that performs no authentication checks on a wireless client before allowing it to associate.

PPPoE (Point to Point Protocol over Ethernet)

A method of allowing the authentication protocol adopted in telephone line connection (PPP) to be used over an Ethernet.

Protocol

A procedure or rule of delivering data among computers. Ordered data communication is allowed by making all conditions required for communication including the method of data transmission/reception and actions upon communication errors into procedures.

Shared key authentication

802.11 network authentication method in which the AP sends the client device a challenge text packet that the client must then encrypt with the correct WEP key and return to the AP. If the client has the wrong key or no key, authentication will fail and the client will not be allowed to associate with the AP. Shared key authentication is not considered secure, because a hacker who detects both the clear-text challenge and the same challenge encrypted with a WEP key can decipher the WEP key.

SSID (Service Set Identifier)

Service Set Identifier, a 32-character unique identifier attached to the header of packets sent over a WLAN that acts as a password when a mobile device tries to connect to the BSS. The SSID differentiates one WLAN from another, so all access points and all devices attempting to connect to a specific WLAN must use the same SSID. A device will not be permitted to join the BSS unless it can provide the unique SSID. Because the SSID is broadcast in plain text, it does not supply any security to the network.

Subnet mask

TCP-IP network is controlled by being divided into multiple smaller networks (subnets). IP address consists of the subnet address and the address of each computer. Subnet mask defines how many bits of IP address comprise the subnet address. The same value shall be set among computers communicating with each other.

TCP/IP (Transmission Control Protocol/Internet Protocol)

A standard protocol of the Internet.

Wi-Fi

Wi-Fi, or Wireless Fidelity, is a set of standards for wireless local area networks (WLAN) based on the IEEE 802.11 specifications. Certified products can use the official Wi-Fi logo, which indicates that the product is interoperable with any other product also showing that logo.

IP address information

ABOUT IP ADDRESSES



IP addressing is much more complicated than can be briefly explained in this document. You are advised to consult with your network administrator for additional information.

If IP address is unknown, set IP address as follows,

or,

If you have an access point (DHCP server) on the network, set the IP address as follows:

[Obtain an IP address automatically]



A DHCP server is a server that automatically assigns IP addresses to computers or other devices in the network. There is no DHCP server for the AdHoc network.

If the IP address is already assigned to the computer in the network, ask the network administrator to check the IP address to be set for the computer.

If no access point is found in the network:

An IP address is expressed with four values in the range between 1 and 255.

Set the each computer as follows: The value in parentheses is a subnet mask.

<Example>

Computer A: 192.168.100.2 (255.255.255.0)

Computer B: 192.168.100.3 (255.255.255.0)

Computer C: 192.168.100.4 (255.255.255.0)

:

:

Computer X: 192.168.100.254 (255.255.255.0)

WLAN Specifications

Item	Specifications
Type of network	The Intel PRO/Wireless 3945ABG Network Connections WLAN device conforms to IEEE 802.11a and 802.11b/g (Wi-Fi based)*. The Intel PRO/Wireless 4965AGN Network Connections WLAN device conforms to IEEE 802.11a, 802.11b/g, and 802.11n (draft), Wi-Fi based*
Transfer rate	(Automatic switching) 54 Mbps maximum data rate (IEEE802.11n rates to be determined)
Active frequency	<ul style="list-style-type: none"> ▪ 802.11n: 2.4 GHz or 5 GHz ▪ 802.11b/g: 2400~2473 MHz ▪ 802.11a: 4900 ~ 5850 MHz
Number of channels	<ul style="list-style-type: none"> ▪ 802.11a: 8 independent channels ▪ 802.11b/g: 11 channels, 3 non-overlapping channels <p>802.11n: 2.4 GHz - 3 non-overlapping channels when Channel Bonding is not used; 2 non-overlapping channels when Channel Bonding is used. 5 GHz - 12 non-overlapping UNII channels with or without Channel Bonding</p>
Typical operating distances**	<ul style="list-style-type: none"> ▪ 802.11a: 40 ft. (12 m) @ 54 Mbps; 300 ft. (91 m) @ 6 Mbps ▪ 802.11b: 100 ft. (30 m) @ 11 Mbps; 300 ft. (91 m) @ 1 Mbps ▪ 802.11g: 100 ft. (30 m) @ 54 Mbps; 300 ft. (91 m) @ 1 Mbps ▪ 802.11n: Estimated double the operating distance of 802.11g and 802.11a in their respective frequencies.
Security	Encryption Types - WEP, TKIP, AES*** WPA 1.0 compliant Encryption Keylengths Supported: 64 bits and 128 bits 802.1x/EAP
Maximum recommended number of computers to be connected over wireless LAN (during ad hoc connection)	10 units or less ****

* "Wi-Fi based" indicates that the interconnectivity test of the organization which guarantees the interconnectivity of wireless LAN (Wi-Fi Alliance) has been passed.

** The communication ranges shown above will increase or decrease depending on factors such as number of walls, reflective material, or interference from external RF sources.

*** Encryption with network key (WEP) is performed using the above number of bits, however, users can set 40 bits/104 bits after subtracting the fixed length of 24 bits.

**** Depending on practical environments, the allowable number of computers to be connected may be decreased.



Appendix B

Using the Fingerprint Sensor

Fingerprint Sensor Device

INTRODUCING THE FINGERPRINT SENSOR DEVICE

Your system has a fingerprint sensor device below the Touchpad, between the left and right buttons. This also serves as a scroll button.



Figure B-1 Fingerprint sensor



Although the system may have a fingerprint sensor in place of a scroll button, the fingerprint sensor can be used for scrolling. Simply move your fingerprint over the sensor the same as you would use a scroll button.

With a fingerprint sensor, you can avoid having to enter a username and password every time you want to:

- Log onto Windows
- Recover from Sleep mode
- Cancel a password-protected screen saver
- Log into homepages that require a username and password

After you have “enrolled” - or registered - your fingerprint, you can simply swipe your fingertip over the sensor for the system recognize you.

The fingerprint sensor uses Softex OmniPass which provides password management capabilities to Microsoft Windows operating systems. OmniPass enables you to use a “master password” for all Windows, applications, and on-line passwords.

The use of OmniPass results in a secure authentication system for restricting access to your computer, applications, websites, and other password-protected resources.

OmniPass presents a convenient graphical user interface, through which you can securely manage passwords, users, and multiple identities for each user.

GETTING STARTED

This section guides you through the preparation of your system for the OmniPass fingerprint recognition application. You will be led through the OmniPass

installation process. You will also be led through the procedure of enrolling your first user into OmniPass.

INSTALLING OMNIPASS

If OmniPass has already been installed on your system, skip this section and go directly to “User Enrollment” on page 100. You can determine whether OmniPass has already been installed by checking to see if the following are present:

- The presence of the gold key-shaped OmniPass icon in the system tray at the bottom right of the screen.
- The presence of the Softex program group in the Programs group of the Start menu

System Requirements

The OmniPass application requires space on your hard drive; it also requires specific Operating Systems (OS's). The minimum requirements are as follows:

- Windows XP Professional operating system
- At least 35 MB available hard disk space

Installing the OmniPass Application

If OmniPass is already installed on your system, go to “User Enrollment” on page 100. (If you have run the ClickMe! utility, it is likely that OmniPass has already been installed on your system.) Otherwise continue with this section on software installation.



For installation, OmniPass requires that the user installing OmniPass have administrative privileges to the system. If your current user does not have administrative privileges, log out and then log in with an administrator user before proceeding with OmniPass installation.

To install OmniPass on your system you must:

1. Insert the installation media for the OmniPass application into the appropriate drive. If you are installing from CD-ROM or DVD-ROM, you must find and launch the OmniPass installation program (setup.exe) from the media.
2. Follow the directions provided in the OmniPass installation program. Specify a location to which you would like OmniPass installed. It is recommended that you NOT install OmniPass in the root directory (e.g. C:\).
3. Once OmniPass has completed installation you will be prompted to restart your system. Once your system has rebooted you will be able to use OmniPass. If you choose not to restart immediately after installation, OmniPass will not be available for use until the next reboot.

The installation program automatically places an icon (Softex OmniPass) in the Windows Control Panel as well as a golden key shaped icon in the system tray.

Verifying Information about OmniPass

After you have completed installing OmniPass and restarted your system, you may wish to check the version of OmniPass on your system.

To check the version information of OmniPass:

1. From the Windows Desktop, double-click the key-shaped OmniPass icon in the system tray (usually located in the lower right corner of the screen),
or,
Click the **Start** button, select **Settings**, and click **Control Panel**. Double-click **Softex OmniPass** in the Control Panel, and the OmniPass Control Center will appear. If it does not appear, then the program is not properly installed,
or,
Click the **Start** button, select **Programs**, and from the submenu select the **Softex** program group, from that submenu click **OmniPass Control Center**.
2. Select the **About** tab at the top of the OmniPass Control Panel. The About tab window appears with version information about OmniPass.

Uninstalling OmniPass



Before you uninstall the software, decrypt all OmniPass encrypted files and export all OmniPass User Profiles. Failure to do so may result in permanent loss of encrypted file data, and permanent loss of all remembered passwords and associated information (see Chapter 5 of the OmniPass help document: Exporting and Importing Users).



For uninstallation, OmniPass requires that the user uninstalling OmniPass have administrative privileges to the system. If your current user does not have administrative privileges, log out and then log in with an administrator user before proceeding with OmniPass uninstallation.

To remove the OmniPass application from your system:

1. Click **Start** on the Windows system tray. Select **Settings**, and then **Control Panel**.
2. Double-click **Add/Remove Programs**.
3. Select **OmniPass**, and then click **Change/Remove**.
4. Follow the directions to uninstall the OmniPass application.
5. Once OmniPass has finished uninstalling, reboot your system when prompted.

USER ENROLLMENT

Before you can use any OmniPass features you must first enroll a user into OmniPass.

Master Password Concept

Computer resources are often protected with passwords. Whether you are logging into your computer, accessing your email, e-banking, paying bills online, or accessing network resources, you often have to supply credentials to gain access. This can result in dozens of sets of credentials that you have to remember.

During OmniPass user enrollment a "master password" is created for the enrolled user. This master password "replaces" all other passwords for sites you register with OmniPass.

Example: A user, John, installs OmniPass on his system (his home computer) and enrolls an OmniPass user with username "John_01" and password "freq14". He then goes to his webmail site to log onto his account. He inputs his webmail credentials as usual (username "John_02" and password "lifebook"), but instead of clicking [Submit], he directs OmniPass to **Remember Password**. Now whenever he returns to that site, OmniPass will prompt him to supply access credentials.

John enters his OmniPass user credentials ("John_01" and "freq14") in the OmniPass authentication prompt, and he is allowed into his webmail account. He can do this with as many websites or password protected resources he likes, and he will gain access to all those sites with his OmniPass user credentials ("John_01" and "freq14"). This is assuming he is accessing those sites with the system onto which he enrolled his OmniPass user. OmniPass does not actually change the credentials of the password protected resource. If John were to go to an Internet cafe to access his webmail, he would need to enter his original webmail credentials ("John_02" and "lifebook") to gain access. If he attempts his OmniPass user credentials on a system other than where he enrolled that OmniPass user, he will not gain access.



The enrollment procedure assumes you have no hardware authentication devices or alternate storage locations that you wish to integrate with OmniPass. If you desire such functionality, consult the appropriate sections of this document.

Basic Enrollment

The Enrollment Wizard will guide you through the process of enrolling a user. Unless you specified otherwise, after OmniPass installation the Enrollment Wizard will launch on Windows login. If you do not see the Enrollment Wizard, you can bring it up by clicking **Start** on the Windows system tray; select **Programs**; select **Softex**; click **OmniPass Enrollment Wizard**.

1. Click **Enroll** to proceed to username and password verification. By default, the OmniPass Enrollment

- Wizard enters the credentials of the currently logged in Windows user.
2. Enter the password you use to log in to Windows. This will become the “master password” for this OmniPass user. In most cases, the **Domain:** value will be your Windows computer name. In a corporate environment, or when accessing corporate resources, the **Domain:** may not be your Windows computer name. Click [Next] to continue.
 3. In this step OmniPass captures your fingerprint. Refer to “Enrolling a Fingerprint” on page 101 for additional information.
 4. Next, choose how OmniPass notifies you of various events. We recommend you keep **Taskbar Tips on Beginner mode taskbar tips** and **Audio Tips** on at least **Prompt with system beeps only** until you get accustomed to how OmniPass operates. Click [Next] to proceed with user enrollment. You will then see a Congratulations screen indicating your completion of user enrollment.
 5. Click [Done] to exit the OmniPass Enrollment Wizard. You will be asked if you’d like to log in to OmniPass with your newly enrolled user; click [Yes].

Enrolling a Fingerprint

Enrolling a fingerprint will increase the security of your system and streamline the authentication procedure.

You enroll fingerprints in the OmniPass Control Center. With an OmniPass user logged in, double-click the system tray OmniPass icon. Select the **User Settings** tab and click **Enrollment** under the **User Settings** area. Click **Enroll Authentication Device** and authenticate at the authentication prompt to start device enrollment.

1. During initial user enrollment, you will be prompted to select the finger you wish to enroll. Fingers that have already been enrolled will be marked by a green check. The finger you select to enroll at this time will be marked by a red arrow. OmniPass will allow you re-enroll a finger. If you choose a finger that has already been enrolled and continue enrollment, OmniPass will enroll the fingerprint, overwriting the old fingerprint. Select a finger to enroll and click [Next].
2. It is now time for OmniPass to capture your selected fingerprint. It may take a several capture attempts before OmniPass acquires your fingerprint. Should OmniPass fail to acquire your fingerprint, or if the capture screen times out, click [Back] to restart the fingerprint enrollment process.

Your system has a “swipe” fingerprint sensor. A swipe sensor is small and resembles a skinny elongated rectangle. To capture a fingerprint, gently swipe or pull your fingertip over the sensor (starting at the second knuckle) **towards yourself**. Swiping

too fast or too slow will result in a failed capture. The **Choose Finger** screen has a [Practice] button; click it to practice capturing your fingerprint. When you are comfortable with how your fingerprint is captured, proceed to enroll a finger.

3. Once OmniPass has successfully acquired the fingerprint, the **Verify Fingerprint** screen will automatically appear. To verify your enrolled fingerprint, place your fingertip on the sensor and hold it there as if you were having a fingerprint captured. Successful fingerprint verification will show a green fingerprint in the capture window and the text **Verification Successful** under the capture window.

USING OMNIPASS

You are now ready to begin using OmniPass. Used regularly, OmniPass will streamline your authentications.

Password Replacement

You will often use the password replacement function. When you go to a restricted access website (e.g., your bank, your web-based email, online auction or payment sites), you are always prompted to enter your login credentials. OmniPass can detect these prompts and you can teach OmniPass your login credentials. The next time you go to that website, you can authenticate with your fingerprint to gain access.

OmniPass Authentication Toolbar

After installing OmniPass and restarting, you will notice a dialog you have not seen before at Windows Logon. This is the OmniPass Authentication Toolbar, and it is displayed whenever the OmniPass authentication system is invoked. The OmniPass authentication system may be invoked frequently: during Windows Logon, during OmniPass Logon, when unlocking your workstation, when resuming from sleep or hibernate, when unlocking a password-enabled screensaver, during password replacement for remembered site or application logins, and more. When you see this toolbar, OmniPass is prompting you to authenticate.

The **Logon Authentication** window indicates what OmniPass-restricted function you are attempting. The icons in the lower left (fingerprint and key) show what authentication methods are available to you. Selected authentication methods are highlighted while unselected methods are not. When you click the icon for an unselected authentication method, the authentication prompt associated with that method is displayed.

When prompted to authenticate, you must supply the appropriate credentials: an enrolled finger for the fingerprint capture window or your master password for the master password prompt (the key icon).

Remembering a Password

OmniPass can remember any application, GUI, or password protected resource that has a password prompt.

Using the following procedure, you can store a set of credentials into OmniPass. These credentials will then be linked to your “master password” or fingerprint.

Go to a site that requires a login (username and password), but *do not log in yet*. At the site login prompt, enter your username and password in the prompted fields, but *do not enter the site* (do not hit [Enter], [Submit], [OK], or Login). Right-click the OmniPass system tray icon and select **Remember Password** from the submenu. The Windows arrow cursor will change to a golden key OmniPass cursor. Click this OmniPass cursor in the login prompt area, but do not click the [Login] or [Submit] button.

Associating a Friendly Name

After clicking the OmniPass key cursor near the login prompt, OmniPass will prompt you to enter a “friendly name” for this site. You should enter something that reminds you of the website, the company, or the service you are logging into. In its secure database, OmniPass associates this friendly name with this website.

Additional Settings for Remembering a Site

When OmniPass prompts you to enter a “friendly name” you also have the opportunity to set how OmniPass authenticates you to this site. There are three effective settings for how OmniPass handles a remembered site.

The default setting is **Automatically click the “OK” or “Submit” button for this password protected site once the user is authenticated**. With this setting, each time you navigate to this site OmniPass will prompt you for your master password or fingerprint authentication device. Once you have authenticated with OmniPass, you will automatically be logged into the site.

Less secure is the option to **Automatically enter this password protected site when it is activated. Do not prompt for authentication**. Check the upper box to get this setting, and each time you navigate to this site OmniPass will log you into the site without prompting you to authenticate.



This setting is more convenient in that whenever you go to a site remembered with this setting, you will bypass any authentication procedure and gain instant access to the site. But should you leave your system unattended with your OmniPass user logged in, anyone using your system can browse to your password protected sites and gain automatic access.

If you uncheck both boxes in **Settings for this Password Site**, OmniPass will prompt you for your master password or fingerprint authentication device. Once you have authenticated with OmniPass your credentials will be filled in to the site login prompt, but you will have to

click the website [OK], [Submit], or [Login] button to gain access to the site.

Click **Finish** to complete the remember password procedure. The site location, the credentials to access the site, and the OmniPass authentication settings for the site are now stored in the OmniPass secure database. The OmniPass authentication settings (**Settings for this Password Site**) can always be changed in **Vault Management**.

Logging in to a Remembered Site

Whether or not OmniPass prompts you to authenticate when you return to a remembered site is determined by **Settings for this Password Site** and can be changed in **Vault Management**.

The following cases are applicable to using OmniPass to login to: Windows, remembered websites, and all other password protected resources.

With Master Password

Once you return to a site you have remembered with OmniPass, you may be presented with a master password prompt. Enter your master password and you will be allowed into the site.

Logging into Windows with a Fingerprint Device

When logging into Windows with a fingerprint device, the fingerprint capture window will now appear next to the Windows Login screen. Place your enrolled fingertip on the sensor to authenticate. You will be simultaneously logged into Windows and OmniPass. The capture window will also appear if you have used **Ctrl-Alt-Del** to lock a system, and the fingerprint device can be used to log back in as stated above.



If a machine is locked and OmniPass detects a different user logging back in with a fingerprint, the first user will be logged out and the second user logged in.

In Windows XP, your login options must be set either for classic login, or for fast user switching and logon screen to be enabled to use your fingerprint to log on to Windows. To change this go to **Control Panel**, select **User Accounts** and then click **Change the way users log on or off**. If your Windows screensaver is password protected, the fingerprint capture window will now appear next to screensaver password dialog during resume. You can authenticate to your screensaver password prompt with your enrolled finger.

Password Management

OmniPass provides an interface that lets you manage your passwords. To access this GUI, double-click the OmniPass key in the system tray. Click **Vault Management**; you will be prompted to authenticate. Once you gain access to **Vault Management**, click **Manage Pass-**

words under **Vault Settings**. You will see the **Manage Passwords** interface, with a list of friendly names.

You can view the credentials stored for any remembered website by highlighting the desired resource under **Password Protected Dialog** and clicking **Unmask Values**. Should a password be reset, or an account expire, you can remove stored credentials from OmniPass. Highlight the desired resource under **Password Protected Dialog** and click **Delete Page**. You will be prompted to confirm the password deletion.

The two check boxes in **Manage Passwords** govern whether OmniPass prompts you to authenticate or directly logs you into the remembered site.

OmniPass will overwrite an old set of credentials for a website if you attempt to use **Remember Password** on an already remembered site.

The exception to the above rule is the resetting of your Windows password. If your password is reset in Windows, then the next time you login to Windows, OmniPass will detect the password change and prompt you to “Update” or “Reconfirm” your password with OmniPass. Enter your new Windows password in the prompt(s) and click **OK** and your OmniPass “master password” will still be your Windows password.

OmniPass User Identities

Identities allow OmniPass users to have multiple accounts to the same site (e.g., *bob@biblomail.com* and *boballen@biblomail.com*). If OmniPass did not provide you identities, you would be limited to remembering one account per site.

To create and manage identities, double-click the OmniPass key in the system tray. Click **Vault Management**; OmniPass will prompt you to authenticate. Once you gain access to **Vault Management**, click **Manage Identities** under **Vault Settings**. You can only manage the identities of the currently logged in OmniPass user

To add a new identity, click **New Identity** or double-click **Click here to add a new identity**. Name the new identity and click [OK], then click [Apply]. You can now switch to the new identity and start remembering passwords.

To delete an identity, highlight the identity you want to delete and click [Delete Identity], then click [Apply].



When you delete an identity, all of its associated remembered sites and password protected dialogs are lost.

cally be logged in to the default identity for that OmniPass user. You can choose the identity with which you are logging in if you login using “master password”.

Choosing User Identity during Login

To choose your identity during login, type your username in the **User Name**: field. Press [Tab] and see that the **Domain**: field self-populates. Click the **Password**: field to bring the cursor to it, and you will see the pull-down menu in the **Identity**: field. Select the identity you wish to login as and then click **OK** to login.

Switch User Identity

To switch identities at any time, right-click the OmniPass system tray icon and click **Switch User Identity** from the submenu. The **Switch Identity** dialog will appear. Select the desired identity and then click **OK**.

Identities and Password Management

On the **Manage Passwords** interface of the **Vault Management** tab of the OmniPass Control Center, there is a pull-down selection box labeled, **Identity**. This field lets you choose which identity you are managing passwords for. When you select an identity here, only those password protected dialogs that are associated with that identity are shown. You can perform all the functions explained in “Password Management” on page 102.

CONFIGURING OMNIPASS

This section gives an overview of both the **Export/Import** function and the OmniPass Control Center.

Exporting and Importing Users

Using the OmniPass Control Center, you can export and import users in and out of OmniPass. The export process backs up all remembered sites, credentials, and any enrolled fingerprints for an OmniPass user. All OmniPass data for a user is backed up to a single encrypted database file. During the import process, the Windows login of the exported user is required. If the

To set the default identity, highlight the identity you want as default and click [Set as Default]; click [Apply] to ensure the settings are saved. If you log in to OmniPass with a fingerprint device, you will automati-

proper credentials cannot be supplied, the user profile will not be imported.



- You should periodically export your user profile and store it in a safe place. If anything happens to your system, you can import your OmniPass profile to a new system and have all your remembered settings and fingerprints instantly.
- You don't forget the Windows login credentials when exporting. When you examine the importation, you are prompted for authentication. The credentials that will allow a user profile to be imported are the Windows login credentials of the exported user. They are the credentials that had to be submitted when the user profile was exported. You will need User Name, Password, and Domain.

Exporting an OmniPass User Profile

To export a user, open the OmniPass Control Center, and click **Import/Export User** under **Manage Users**.

Click **Exports an OmniPass user profile**. OmniPass will prompt you to authenticate. Upon successfully authentication, you must name the OmniPass user profile and decide where to save it. An .opi file is generated, and you should store a copy of it in a safe place.

This .opi file contains all your user specific OmniPass data, and it is both encrypted and password protected. This user profile does NOT contain any of your encrypted data files.

Importing an OmniPass User Profile



You cannot import a user into OmniPass if there already is a user with the same name enrolled in OmniPass.

To import an OmniPass user open the OmniPass Control Center, and click **Import/Export User** under **Manage Users**. Click **Imports a new user into OmniPass** and then select **OmniPass Import/Export File (*.opi)** and click **Next**. OmniPass will then prompt you to browse for the file you had previously exported (.opi file). When you select the .opi file for importation, OmniPass will prompt you for authentication. The credentials that will allow a user profile to be imported are the Windows login credentials of the exported user. They are the credentials that had to be submitted when the user profile was exported. You will need **User Name**, **Password**, and **Domain**. If you don't remember the value for **Domain**, in a PC or SOHO environment **Domain** should be your computer name.

OmniPass will notify you if the user was successfully imported.

Things to Know Regarding Import/Export

- Assume you export a local Windows User profile from OmniPass. You want to import that profile to another machine that has OmniPass. Before you can import the profile, a Windows user with the same login credentials must be created on the machine importing the profile.

Example: I have a Windows user with the username "Tom" and the password "Sunshine" on my system. I have enrolled Tom into OmniPass and remembered passwords. I want to take all my passwords to new system. I export Tom's OmniPass user profile. I go to my new system and using the Control Panel I create a user with the username "Tom" and the password "Sunshine". I can now successfully import the OmniPass user data to the new system.

- If you export an OmniPass-only user, you can import that user to any computer running OmniPass, provided that a user with that name is not already enrolled in OmniPass.
- If you attempt to import a user profile who has the same name as a user already enrolled in OmniPass, the OmniPass import function will fail.

OMNIPASS CONTROL CENTER

This section will serve to explain functions within the OmniPass Control Center that weren't explained earlier.

You can access the OmniPass Control Center any of three ways:

- Double-click the golden OmniPass key shaped icon in the Windows system tray (typically in the lower-right corner of the desktop)
- Click the **Start** button; select the **Programs** group; select the **Softex** program group; and click the **OmniPass Control Center** selection.
- Open the Windows **Control Panel** (accessible via **Start** button --> **Settings** --> **Control Panel**) and double-click the **Softex OmniPass** icon.

User Management

The User Management tab has two major interfaces: **Add/Remove User** and **Import/Export User**. Import/Export User functionality is documented in "Exporting and Importing Users" on page 103. Add/Remove User functionality is straightforward.

If you click **Adds a new user to OmniPass** you will start the OmniPass Enrollment Wizard. The Enrollment Wizard is documented in "User Enrollment" on page 100.

If you click **Removes a user from OmniPass**, OmniPass will prompt you to authenticate. Authenticate with the credentials (or enrolled fingerprint) of the user you wish

to remove. OmniPass will prompt you to confirm user removal. Click OK to complete user removal.



Removing a user will automatically destroy all OmniPass data associated with that user. All identities and credentials associated with the user will be lost.

If you are sure about removing the user, we recommend you export the user profile.

User Settings

The User Settings tab has four interfaces: **Audio Settings**, **Taskbar Tips**, and **Enrollment**. User settings allow users to customize OmniPass to suit their individual preferences. Under **User Settings** (**Audio Settings** and **Taskbar Tips**) you can set how OmniPass notifies the user of OmniPass events (e.g., successful login, access denied, etc.). The details of each setting under the **Audio Settings** and **Taskbar Tips** interfaces are self-explanatory.

The **Enrollment** interface allows you to enroll fingerprints. To enroll additional fingerprints, click **Enroll Authentication Device**, and authenticate with OmniPass. Select the fingerprint recognition device in the **Select Authentication Device** screen (it should already be marked by a green check if you have a finger enrolled) and click **Next**.

System Settings

The OmniPass **Startup Options** interface can be found in the System Settings tab. With these options you can specify how your OmniPass Logon is tied to your Windows Logon.

The first option, **Automatically log on to OmniPass as the current user**, will do just as it says; during Windows login, you will be logged on to OmniPass using your Windows login credentials. If the user logging into Windows was never enrolled into OmniPass, upon login no one will be logged on to OmniPass. This setting is appropriate for an office setting or any setting where users must enter a username and password to log into a computer. This is the default setting.

With the second option, **Manually log on to OmniPass at startup**, OmniPass will prompt you to login once you have logged on to Windows.

With the third option, **Do not log on to OmniPass at startup**, OmniPass will not prompt for a user to be logged on.

You can manually log on to OmniPass by right-clicking the OmniPass system tray icon and clicking **Log in User** from the right-click menu.

TROUBLESHOOTING

You cannot use OmniPass to create Windows users. You must first create the Windows user, and you will need administrative privileges to do that. Once the Windows user is created, you can add that user to OmniPass using the same username and password

Cannot add Windows users to OmniPass

If you experience difficulties adding a Windows user to OmniPass, you may need to adjust your local security settings. You can do this by going to **Start**, **Control Panel**, **Administrative Tools**, and **Local Security Settings**. Expand **Local Policies**, expand **Security Options**, and double-click **Network Access: Sharing and Security Model for Local Accounts**. The correct setting should be *Classic - Local Users Authenticate as Themselves*.

Cannot add a User with a Blank Password to OmniPass

If you experience difficulties adding a user with a blank password to OmniPass, you may need to adjust your local security settings. First attempt the procedure explained in the *Cannot add Windows user to OmniPass* section. If the difficulties persist, then try the following procedure.

Click **Start**, **Control Panel**, **Administrative Tools**, and **Local Security Settings**. Expand **Local Policies**, expand **Security Options**, and double-click **Accounts: Limit local account use of blank passwords to console login only**. This setting should be set to **Disabled**.

Dialog appears after OmniPass authentication during Windows Logon

After installing OmniPass on your system, you can choose to logon to Windows using OmniPass. You authenticate with OmniPass (via master password, or an enrolled security device) and OmniPass logs you into Windows. You may, during this OmniPass authentication, see a **Login Error** dialog box.

This dialog box occurs when OmniPass was unable to log you into Windows with the credentials supplied (username and password). This could happen for any of the following reasons:

- Your Windows password has changed
- Your Windows account has been disabled

If you are having difficulties due to the first reason, you will need to update OmniPass with your changed Windows account password. Click **Update Password** and you will be prompted with a dialog to reconfirm your password.

Enter the new password to your Windows user account and click **OK**. If the error persists, then it is unlikely the problem is due to your Windows user account password changing.



Index

A

- AC
 - adapter25, 74, 79
 - plug adapters68
- Application/Media Player Buttons9
- Audio73
- Auto Insert Notification41
- Auto/Airline Adapter25
- Automatically Downloading Driver Updates64

B

- Battery57, 58
 - bay14
 - care68
 - charging indicators15
 - conserving power30
 - dead57
 - faulty58
 - increasing life68
 - lithium ion battery37, 80
 - low37
 - recharging37
 - replacing38
 - shorted38
 - sleep mode37
 - status indicator15
- Battery Pack Lock14
- BIOS79
 - Guide28
 - memory73
 - setup utility27
- Boot79
- BOOT Priority Change63
- Boot Sequence27
- Built-in Speakers54

C

- Cache Memory73, 79
- CapsLock Indicator15
- Click Me!29
- Clicking19
- Color Resolution73
- Communications Port47
- Cursor19
- Cursor Keys16

D

- DC In Jack13, 25
- DC Output Cable25
- Device Ports47, 74
- Disk Care68
- Display Panel8, 59
 - adjusting26
 - brightness26
 - closing26
 - latch8
 - opening26
- Double-Clicking19
- Dragging20
- Drivers and Application Restore CD63
- DVD/CD-ROM39, 69

E

- Error Messages61
- ExpressCards43
- Extended Memory80
- External Monitor Port13, 49

F

- Fingerprint Recognition Sensor9
- Fingerprint Sensor Device99
 - enrolling a fingerprint101
 - getting started99
 - installing OmniPass99
 - logging into a remembered site102
 - OmniPass authentication toolbar101
 - password replacement101
 - remembering a password101
 - uninstalling OmniPass100
 - user enrollment100
 - using OmniPass101
- Floppy Disk Drive68, 73
- Fujitsu Driver Update utility29, 64, 75
- Function Key
 - F1017
 - F317
 - F417
 - F617
 - F717
 - F817
 - F917
 - FN17

H

Hard Disk Drive	42, 55, 73
access indicator	15
formatting	42
internal	42
Headphone Jack	48
Hibernation Feature	31

I

IEEE 1394 Port	11, 47
Integrated Pointing Device	74

K

Keyboard	16, 55, 74
cursor keys	16
function keys	16
numeric keypad	16
windows keys	16

L

LAN port	13, 47
LifeBook	
care	67
storing	67
traveling	67

M

Memory	73
capacity	46
compartment	14, 45
installing	45
removing	46
upgrade module	45
Memory Stick	35
Memory Stick/SD/xD Card	35
installing	35
removing	36
slot	11
Memory Upgrade Module	56
Microphone Jack	48
Microsoft Works	76
Modem Jack	13, 47
Modem Result Codes	62

N

Numeric Keypad	16
NumLk Indicator	15

O

OmniPass	75
Optical Drive	10, 39, 73
Control Panel	40
loading	39
removing media	39
tray release	40
using	40
Optical Drive Eject Button	12

P

Parallel Port	81
PC Card	56, 57
care	69
removing	43, 44
slot	11
PC Card Eject Button	11
POST	81
Power	74
AC adapter	25
failure	57
management	30
off	31
on	27
Power On Self Test	27, 61
Power/Suspend/Resume button	9, 27, 30, 58
Pre-Installed Software	75
Adobe Acrobat Reader	75
Fujitsu HotKey	75
Google Toolbar	75
LifeBook Application Panel	75
manuals	75
Norton Internet Security	75
PowerDVD	75
Quicken New User	75

R

Registration	29
Restarting	31
Restoring the Factory Image	63
Restoring Your Pre-installed Software	63
RJ-11	47

S

ScrLk Indicator	15
SD Card	
Installing	35
removing	36

Secure Digital Card	36
Serial Port	82
Sleep Mode	30, 82
Specifications	73
Status Indicator Panel	8, 10, 15
Stereo Speakers	10
Subwoofer	14
S-Video Out Port	13

T

Theft Prevention Lock Slot	74
TouchPad	19
buttons	19
controls	20
Touchpad Pointing Device	9
Touchpad Pointing Device	10
Troubleshooting	53

U

Universal Serial Bus Port	48
Unpacking	7
USB	14, 48, 56
Using the Media Player	22

V

Video RAM	73
Visual Optimizer	22
Visual Optimizer Button	8
Volume Control	9, 18

W

Windows keys	16
Application key	16
Start keys	16
Wireless LAN	
Before Using the Wireless LAN	88
Connection using Wireless Zero Tool	90
IP address information	94
Specifications	95
Troubleshooting	91
Wireless LAN Glossary	92
Wireless LAN Switch	9

X

xD Card	
Installing	35
Removing	36

